

3400 Series

Flat Panel Industrial PC

Hardware Reference

<i>Revision</i>	<i>Description</i>	<i>Date</i>
A	Manual Released	5/99
B	3412 and Notes on Windows CE Added	10/99
C	Touchscreen updates	7/02

Trademark Information

Brand or product names are registered trademarks of their respective owners. Windows is a registered trademark of Microsoft Corp. in the United States and other countries.

Copyright Information

This document is copyrighted by XYCOM AUTOMATION Incorporated (Xycom) and shall not be reproduced or copied without expressed written authorization from Xycom.

The information contained within this document is subject to change without notice.

United States FCC Part 15, Subpart B, Class A EMI Compliance Statement:

NOTE: This equipment has been tested and found to comply with the limits for a Class A digital device, pursuant to part 15 of the FCC Rules. These limits are designed to provide reasonable protection against harmful interference when the equipment is operated in a commercial environment. This equipment generates, uses, and can radiate radio frequency energy and, if not installed and used in accordance with the instruction manual, may cause harmful interference to radio communications. Operation of this equipment in a residential area is likely to cause harmful interference in which case the user will be required to correct the interference at his own expense.

For European Users - WARNING:

This is a Class A product. In a domestic environment this product may cause radio interference in which case the user may be required to take adequate measures.

INSTALLATION: Electromagnetic Compatibility WARNING

The connection of non-shielded equipment interface cables to this equipment will invalidate FCC EMI and European Union EMC compliance and may result in electromagnetic interference and/or susceptibility levels which are in violation of regulations which apply to the legal operation of this device. It is the responsibility of the system integrator and/or user to apply the following directions which relate to installation and configuration:

1. All interface cables must include shielded cables. Braid/foil type shields are recommended. Communication cable connectors must be metal, ideally zinc die-cast backshell types, and provide 360 degree protection about the interface wires. The cable shield braid must be terminated directly to the metal connector shell, ground drain wires alone are not adequate.
2. Protective measures for power and interface cables as described within this manual must be applied. Do not leave cables connected to unused interfaces or disconnected at one end. Changes or modifications to this device not expressly approved by the manufacturer could void the user's authority to operate the equipment.
3. EMC compliance is, in part, a function of PCB design. Third party add-on AT/XT peripheral PCB assemblies installed within this apparatus may void EMC compliance. FCC/CE compliant PCB assemblies should always be used where possible. XYCOM can accept no responsibility for the EMC performance of this apparatus after system integrator/user installation of PCB assemblies not manufactured and/or expressly tested and approved for compliance by XYCOM. It is the responsibility of the system integrator/user to ensure that installation and operation of such devices does not void EMC compliance.

Table of Contents

Chapter 1 – System Overview	6
Standard Features	6
Optional Features	7
Unpacking the System	8
Quick Start-up	8
Chapter 2 – Testing	10
Preparing for the Tests	10
Running the Tests	12
Chapter 3 – Installation	13
Front Panel	13
3408T/3410T Front Panel	13
3408KP Front Panel	14
3410KP and 3410KPT Front Panel	16
3412KPT Front Panel	18
3412KP Front Panel	19
3408/3410/3412 I/O Panel	20
Back Panel	21
Power Panel	22
3408/3410 Power Panels	22
Installing Internal Hardware Options	23
DRAM Single In-line Memory Modules (SIMMs)	23
PC/104 Boards	26
Installing External Hardware Options	27
External Floppy Drive	27
Creating a Customized Logo	27
Creating Customized Keypad Inserts	28
3408KP Keypad Inserts	28
3410KP/3412KP Keypad Inserts	31
Installing Operating Systems	33
Installing Ethernet Drivers	34
Installing Video Drivers	34
Using a Touchscreen	35
Installing Touchscreen Drivers	35
Specifying a Touchscreen Port	36
Calibrating the Touchscreen	37
Creating a Power Cable	39
AC Power Cable	39
DC Power Cable	40
Installing the System into a Panel	42
System Power	42
Excessive Heat	43
Electrical Noise	43
Line Voltage Variation	43
Mounting Considerations	44
Mounting the Unit	44
Power Supply	50
AC Power Supply	50
DC Power Supply	50

Expansion Power	50
Hazardous Location Installations	50
Definitions	52
Group Ratings.....	53
Enclosures	54
Power Switch.....	54
Cable Connections.....	54
Operation and Maintenance.....	55
Safety Agency Approval.....	56
Chapter 4 – Keypad Functionality (3408KP/3410KP/3412KP)	57
Control Keypad	57
3408KP.....	57
3410KP/3412KP.....	57
Alternate Configuration.....	58
Function and Alpha Modes.....	58
Contrast Control	59
Numeric Keypad.....	59
Cursor Control Keypad.....	59
Function/Alpha Keypads	60
3408KP.....	60
3410KP.....	60
Chapter 5 – Keypad Utility 3408KP/3410KP/3412KP	62
Loading the Keypad Utility	62
Using the Keypad Utility.....	62
Startup	63
Utility Batch Mode.....	63
Main Menu	63
Exit	64
Files Menu.....	64
Macros Keypad Type Menu	64
Macros Edit Menu	65
Upload Menu	66
Download Menu	67
Utilities Menu.....	67
Keypad Scan Codes.....	68
Chapter 6 – Maintenance	74
Preventive Maintenance	74
Xycom Recommended Hard Drive Preventative Maintenance	74
Replacing the Fuse	75
Chemical Compatibility.....	75
Compatible Lubricants.....	76
Compatible Cleaning Agents	77
Non-compatible Cleaning Agents.....	77
Spare Parts.....	77
Product Repair Program/Returning a Unit to Xycom Automation	78
Appendix A– Technical Specifications	80
Hardware Specifications.....	80
Environmental Specifications.....	81

Appendix B – Pinouts	82
Parallel Port Connector	82
PS/2 Keyboard Connector	83
Mouse Port Connector.....	83
External Floppy Drive Connector.....	84
Power Connector	84
Ethernet Connector.....	84
COM1 Connector	85
RS-232 Connector	85
RS-485 Connection.....	85
COM2 Connector	86
Appendix C – Replacing Flat-Panel Display Bulbs	87
3408 Units	87
3410 Units	89
3412 Units	91
Appendix D – Installing the IDE Flash Drive.....	93
Installing the IDE Flash Drive.....	93
Configuring the IDE Flash Drive.....	94

Chapter 1 - System Overview

The 3408, 3408KP, 3410, 3410KP, 3410KPT, 3412KP(T) and 3412T Industrial PCs combine a PC/AT computer with a flat-panel display to offer a powerful, compact package for the factory floor and other harsh environments.

The units feature an open architecture to meet a variety of applications requiring both a powerful PC and a durable industrial enclosure. The units' front panels—sealed to NEMA 4/4X/12—are protected by an impact-resistant shield.

The units' processor boards combine all the functions of an IBM PC/AT-compatible computer on an industrially hardened circuit board. Refer to the Xycom Automation CHIP4e+ CPU manual for more information on processor and hardware features.

Standard Features

The units offer the following standard features:

- 3.3-inch (3408 and 3408KP) and 3.5-inch (3410, 3410KP, 3410KPT, 3412T and 3412KP(T)) mounting depth
- Flat-panel displays
 - 7.7-inch STN flat-panel display, 640x480 (3408 and 3408KP)
 - 10.4-inch TFT flat-panel display (3410, 3410KP and 3410KPT)
 - 12.1-inch flat panel color display, 800x600 (SVGA) 3412T, 3412KP(T)
- CHIP4e+ board, which supports the latest 5x86 technology
 - 133 MHz AMD5x86 processor
 - 72-pin EDO DRAM SIMM site support (16, 32, and 64 MB)
 - PCI 64-bit video controller, 1-MB video RAM
 - PCI-bus IDE controller
 - 10BASE-T/100 BASE-TX Ethernet controller

Note

Refer to the board manual for more information on the system's Ethernet capabilities.

- Numerous I/O ports
 - RS-232 and RS-232/RS-485 COM ports
- Parallel port
- PS/2 mouse and keyboard ports
- IrDA-compatible infrared port (not supported by Windows CE)
- AC input power

- Flash BIOS
- External floppy connector
- PC/104 expansion site, allowing you to stack two PC/104 boards
- Status LEDs: Power, Disk, COM and Input (3408T, 3410T)
- MS-DOS[®] (MS-DOS is not included if you order Windows[®] 95, Windows NT[®] or Windows CE)
- NEMA 4/4X/12 sealed front panel
- Class I, Division 2 hazardous location approval (not available on units with fieldbus or control options installed)

The 3408KP, 3410KP and 3412KP also include function, control, numeric, alpha, and cursor control keypads.

Optional Features

The following optional features are available:

- Windows 95, Windows NT or Windows CE preinstalled
- Windows NT touchscreen driver (serial port only; included if Windows NT is ordered preinstalled)
- OS/2 touchscreen driver (serial port only)
- Hot installable external floppy drive (not supported by Windows CE)
- 24-volt DC power supply
- 10- or 20-Mbyte IDE Flash drives
- NEMA 4-sealed panel-mount door for front access to keyboard and external floppy port connectors (with mounting hardware)

Unpacking the System

Note

The following list pertains to a basic PC-only system. If a Xycom Automation OpenHMI or OpenCNTRL workstation has been purchased, a more complete packing list may be found in a separate Quickstart manual.

When you remove the system from its box, verify that you have the parts listed below. Save the box and inner wrapping in the event you need to reship the unit.

- 3408, 3408KP, 3410, 3410KP, 3410KPT, 3412T or 3412KP(T)
- Documentation kit:
 - Power connector
 - Diagnostic software disk (MS-DOS units only)
 - Eight 8-32 hex nuts (3408s) or twelve 10-32 hex nuts (3410/12s)
 - Cable clamp and screw (for strain relief of power cord)
 - Four standoffs and four 4-40 screws for mounting PC/104 expansion cards
 - Documentation Library CD-ROM
 - Utility disks
- Business reply card

If you ordered the system with a touchscreen installed, you will also receive a touchscreen driver and manual. These items can be found on the Xycom Documentation CD which is shipped with the unit.

Quick Start-up

Note

The following steps pertain to a basic PC-only system. If a Xycom Automation OpenHMI or OpenCNTRL workstation has been purchased, more complete instructions are included in a separate Quickstart manual.

This section provides the steps to get the system operating, without explaining system capabilities and options.

Warning

Disconnect the power cord before making any adjustments to the inside or outside of the computer.

Perform the following steps to prepare the system for use:

1. Attach optional equipment following the instructions in Chapter 3.
2. Attach the power cord from the power receptacle to a properly grounded 90-250 VAC, 50-60 Hz outlet. (See Chapter 3, *Creating a Power Cable*.)
3. Turn on power to the unit. The system will boot up into the operating system.
4. On the 3408 unit, adjust the contrast by using the contrast keys on the front panel.
On the 3408KP unit, adjust the contrast by pressing and holding the “F/A” key, and then pressing the left or right arrow key to increase or decrease contrast.

Note

You cannot manually adjust contrast on 3410/12 units with active color flat-panel displays; the contrast is adjusted automatically.

5. Install application software via the external floppy, the network, or the IR port.

Chapter 2 - Testing

If your system ships with MS-DOS, Xycom Automation provides diagnostic tests to verify system hardware functions. If a test fails, either you do not have the correct default setting or there has been a hardware failure. Check the default settings and run the tests again. If another failure occurs, contact Xycom Automation's Product Repair and Customization Department (see Chapter 6).

Note

Unexpected failures may occur if you run Xycom Automation diagnostics with device drivers or memory resident programs (TSRs) installed on the system. Remove these before running any diagnostic tests.

Make sure the BIOS setup menus are configured properly (default settings). To access the setup menus,

- Press F2 after the memory tests.
- Make the necessary changes by following the on-screen directions.
- Press ESC.
- Press ENTER twice to save the setup and exit.

Refer to your CPU manual for more information on the BIOS setup menus.

Preparing for the Tests

You need the following equipment to test your system:

- Floppy disk drive
- IBM PC/AT or PS/2-compatible keyboard
- 3.5-inch, DS/DD (bootable) Xycom Automation system test disk (Xycom Automation part number 99290-001)
- Centronics-compatible printer cable
- Parallel printer (Centronics-style interface)
- Two serial loopback test connectors (refer to Figure 2-1 for pinouts)
- 3.5-inch, DS/HD (1.44 Mbyte) disk, formatted

Perform the following steps before starting the tests:

1. Place the CPU board jumpers to the factory-set positions. Refer to your CPU manual for these settings.
2. Plug the female end of the AC power cable into the bottom of the unit and the male end into a properly grounded outlet.

- 3. Connect the serial loopback connector(s) and the printer cable to the appropriate connectors and connect a PC/AT or PS/2 keyboard. Figure 2 -1 illustrates the wiring necessary for the loopback connection.

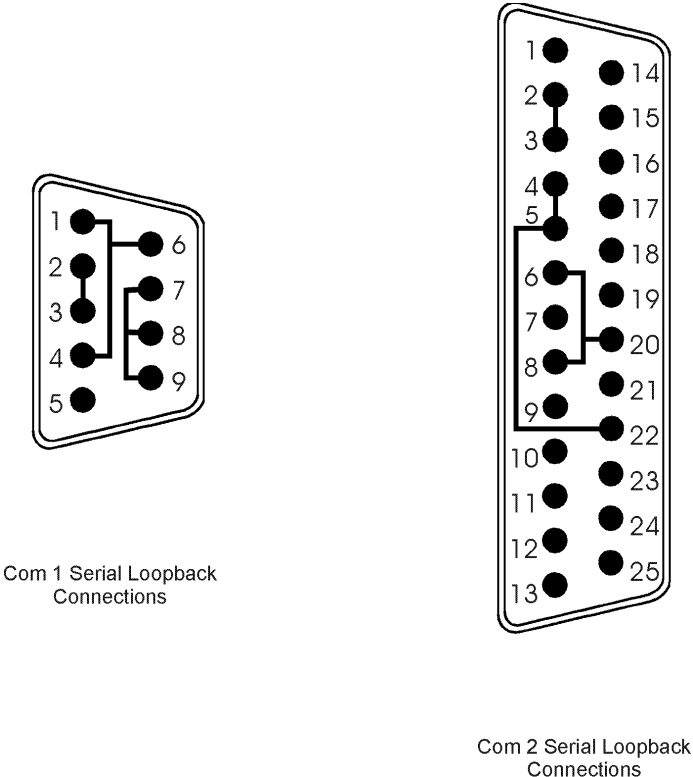

Figure 2-1. Serial Loopback Connections

- 4. Make sure the BIOS setup menus are set to the default settings.

Running the Tests

To run the tests, insert the diagnostics disk into drive A. Turn on the computer (the diagnostics program will boot-up). Figure 2 -2 illustrates the Main Menu.

Copyright 1990-1996, Xycom Automation, Inc. All rights reserved.	
Diagnostic Tests Sequence/Selection Menu (Rel. xx)	
1. WILL pause on error	5. Auto-select tests
2. SINGLE PASS test mode	6. Deselect all tests
3. Save setup to file	7. Quit and exit to DOS
4. Extract setup from a file	8. Return to previous screen
A) RAM Test	K) Video Interface Test
B) Video RAM Test	L) Speaker Port Test
C) Extended RAM Test	M) LPT1: Printer Port Test
D) Real Time Clock Test	N) LPT2: Printer Port Test
E) COM1 Serial Port Test	O) C: Hard Drive Interface Test
F) COM2 Serial Port Test	P) D: Hard Drive Interface Test
G) COM3 Serial Port Test	Q) A: Floppy Drive Interface Test
H) COM4 Serial Port Test	R) B: Floppy Drive Interface Test
I) Math Coprocessor Test	S) Keyboard, Keypad Tests
J) Video Adjustments Test	≡ = Test Selected
[ENTER]=START TESTING	
Use the letters to move the cursor and select/deselect, or use the arrow keys to move, then use the [SPACE] key to select/deselect a test or function.	

Figure 2-2. Main Menu

Note

Please read the DIAG.TXT file on the diagnostics disk for detailed information about the tests.

Chapter 3 -- Installation

This chapter describes how to install the 3408, 3410 and 3412 systems and their available options.

Front Panel

The 3408, 3410 and 3412 units come with a NEMA 4/4X/12 sealed front panel. The panel protects the system's interior when the system is properly panel mounted.

3408T/3410T Front Panel

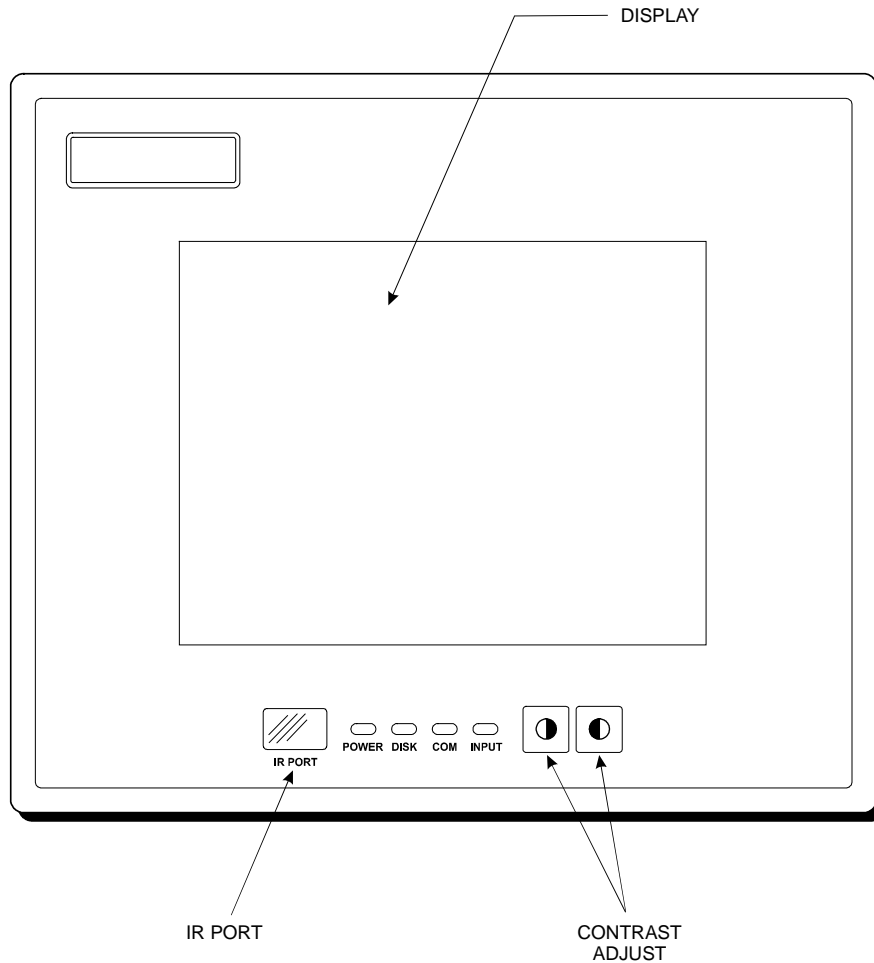



Figure 3-1. 3408T/3410T Front Panel

Feature	Description
---------	-------------

Feature	Description
Display	The 3408T ships with a 7.7-inch STN passive color LCD flat-panel display with an impact-resistant shield. The 3410T ships with a 10.4-inch TFT active matrix color LCD flat-panel.
IR (Infrared) Port 	The IR port transceiver is located behind this window. The port is IrDA and ASKIR compliant, allowing you to connect the unit to any IrDA-compatible device. You must load special software (not included) to use this feature. When enabled through the BIOS Setup menu, the IR link is designed to operate at a distance of 0 to 1 meter. <i>Note: COM2 is not available for other use when you select the IR port in the BIOS Setup menus.</i>
Diagnostic LEDs	<p>Power On (green) when there is power to the unit.</p> <p>Disk On (green) when the computer module is accessing the disk drive.</p> <p>COM On (green) when there is communication on one of the computer module's serial ports, including communication between the computer module and the touchscreen (if attached to COM2) or a serial mouse.</p> <p>Input On (green) when the unit has a touchscreen. This LED gets brighter when it detects a touch input.</p>
Contrast Control Keys	These two keys control the contrast. The left key decreases contrast; the right key increases contrast. <i>Note: You cannot manually adjust contrast on 3410/12T units with TFT active color flat-panel displays; contrast is adjusted automatically on these units.</i>

3408KP Front Panel

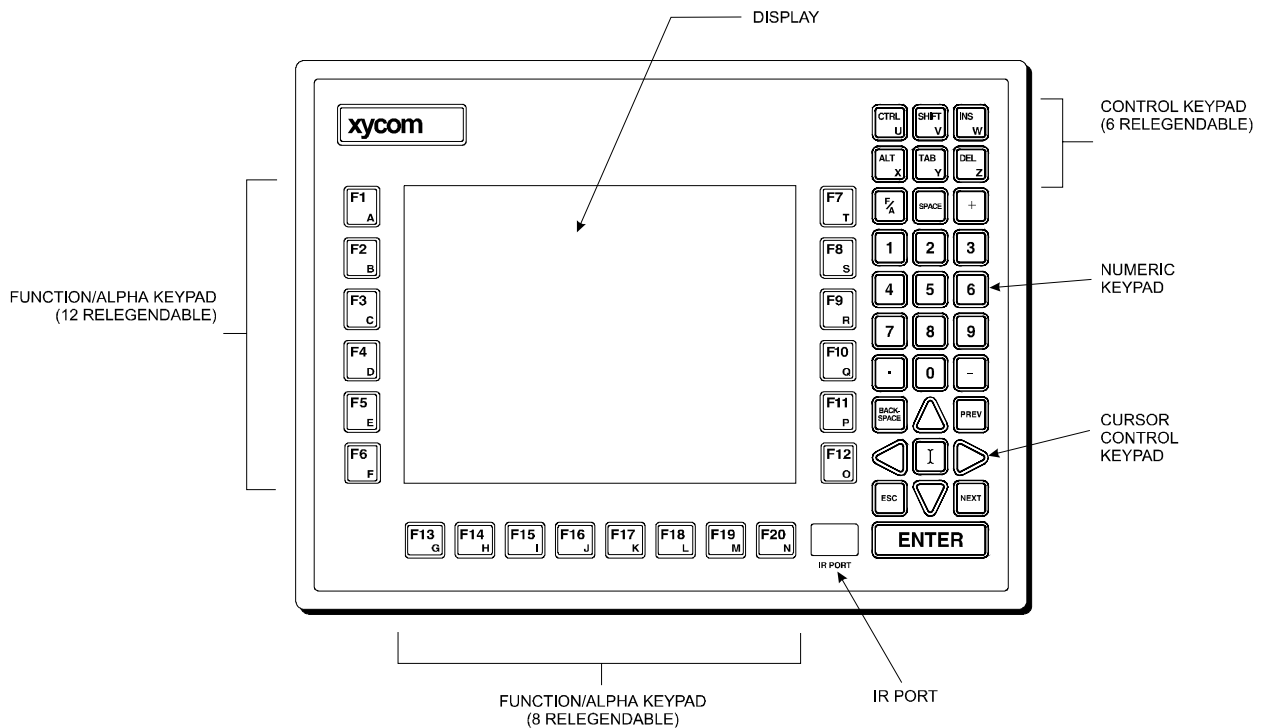



Figure 3-2. 3408KP Front Panel

Note

Refer to Chapter 4 for information on using the keypads, and Chapter 5 for information on reprogramming the keys (not currently applicable to Windows CE).

Feature	Description
Display	The 3408KP ships with a 7.7-inch STN passive color LCD flat-panel display with an impact-resistant shield.
IR (Infrared) Port 	This port is IrDA and ASKIR compliant, allowing you to connect the unit to any IrDA-compatible device. You must load special software (not included) to use this feature. When enabled through the BIOS Setup menu, the IR link is designed to operate at a distance of 0 to 1 meter. <i>Note: COM2 is not available for other use when you select the IR port in the BIOS Setup menus.</i>
Function/Alpha Keypads	The keypads provide function keys F1-F20, as well as uppercase letters A-T. These keys are relegendable (refer to <i>Customizing Keypad Inserts</i> later in this chapter).
Control/Alpha keypad	<p>This keypad provides the CTRL, SHIFT, INS, ALT, TAB, DEL, F/A, SPACE, and + keys, as well as the uppercase letters U-Z. (The CTRL, SHIFT, INS, ALT, TAB, and DEL keys are relegendable.)</p> <p>The F/A key toggles the keypads between function and alpha mode. When the F/A key is not pressed, the keypads are in function mode. When you press and hold the F/A key, the keypads are in alpha mode (refer to Figure 3-2 to determine the location of the alpha characters).</p> <p>You can also use the F/A key to adjust contrast on the flat-panel display. To do this, hold down the F/A key while pressing a cursor control key.</p>
Numeric keypad	This keypad provides numbers 0-9, as well as a decimal point and a minus sign.
Cursor control keypad	This keypad controls cursor movement. It also provides contrast control when used in conjunction with the F/A key.

3410KP and 3410KPT Front Panel

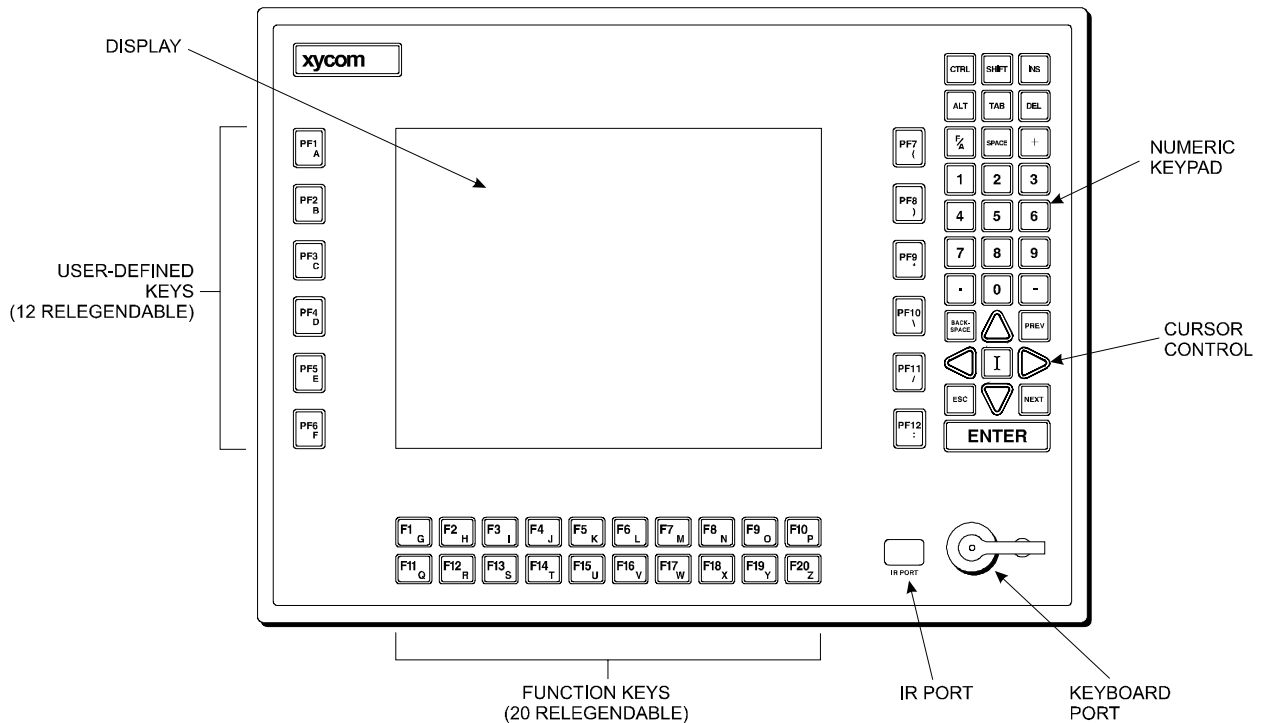

Figure 3-3. 3410KP Front Panel

Feature	Description
Display	The 3410KP ships with a 10.4-inch TFT active matrix color LCD flat-panel. An optional touchscreen (KPT) is also available.
IR (Infrared) Port	This port is IrDA and ASKIR compliant, allowing you to connect the unit to any IrDA-compatible device. You must load special software (not included) to use this feature. When enabled through the BIOS Setup menu, the IR link is designed to operate at a distance of 0 to 1 meter. <i>Note: COM2 is not available for other use when you select the IR port in the BIOS Setup menus.</i>
PF/Function/Alpha Keypads	The keypads provide function keys F1-F20, PF keys 1-12 (PF keys 7-12 also include punctuation symbols), as well as uppercase letters A-Z. These keys are relegendable (refer to <i>Customizing Keypad Inserts</i> later in this chapter).
Control keypad	This keypad provides the CTRL, SHIFT, INS, ALT, TAB, DEL, F/A, SPACE, and + keys. (The CTRL, SHIFT, INS, ALT, TAB, and DEL keys are relegendable.) These keys work the same as they do on a keyboard. The F/A key toggles the keypads between function and alpha mode. When the F/A key is not pressed, the keypads are in function mode. When you press and hold the F/A key, the keypads are in alpha mode (refer to Figure 3-3 to determine the location of the alpha characters).

Feature	Description
Numeric keypad	This keypad provides numbers 0-9, as well as a decimal point and a minus sign.
Cursor control keypad	This keypad controls cursor movement.
Keyboard Port (front access)	The 3410KP provides both front- and rear-accessible PS/2 keyboard connectors. The front-accessible connector is located on the lower right side of the front panel. The rear accessible connector is located on the side of the unit.

Note

A pointing device using the auxiliary port may not operate reliably in conjunction with an 84-key keyboard. Use of this combination is not recommended.

Note

Only one keyboard port on the 3410KP can be used at a time.

3412KPT Front Panel

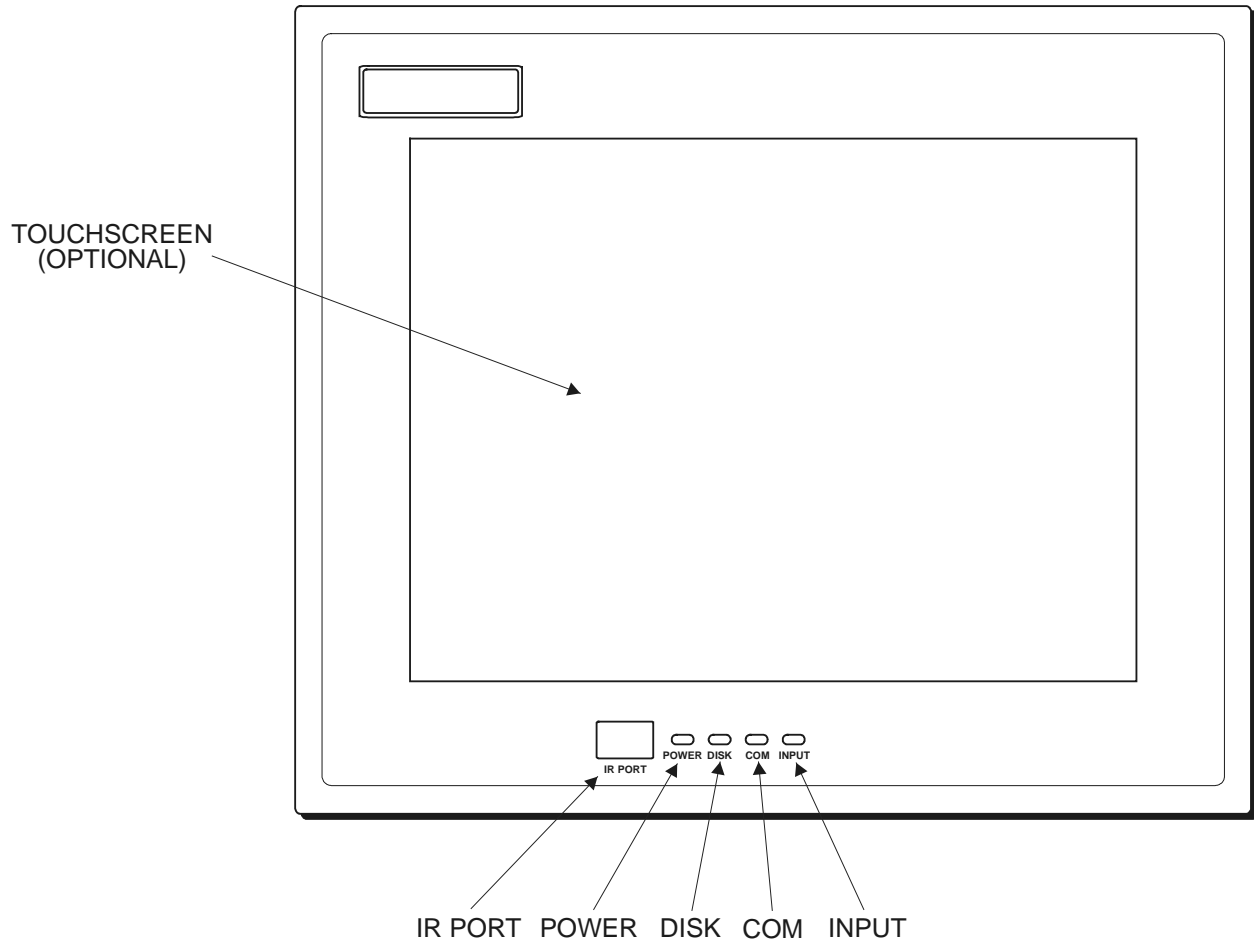

Figure 3-4. 3412KPT Front Panel

Feature	Description
Display	The 3412 comes standard with a 12.1-inch TFT flat panel. Impact-resistant shields protect the displays from breakage. If a touchscreen is factory installed, the touchscreen is backed by heat-annealed safety glass replacing the impact-resistant shield.
System Status LEDs	In this application, the system status LEDs are not enabled.
IR (Infrared)	The IR port transceiver is located behind this window. The 3412 IR port is IrDA, and ASK-IR compliant. You can connect the 3412 to any IrDA compatible device, if you load special software (not included). The infrared (IR) link operates at a distance of 0 to 1 meter and is capable of 115 K baud transfer rates. Enable the interface through the BIOS setup menus. <i>Note: When the IR port is chosen, COM2 is not available. Correspondingly, if COM2 is in use by the touchscreen the IR is not operational.</i>

3412KP Front Panel

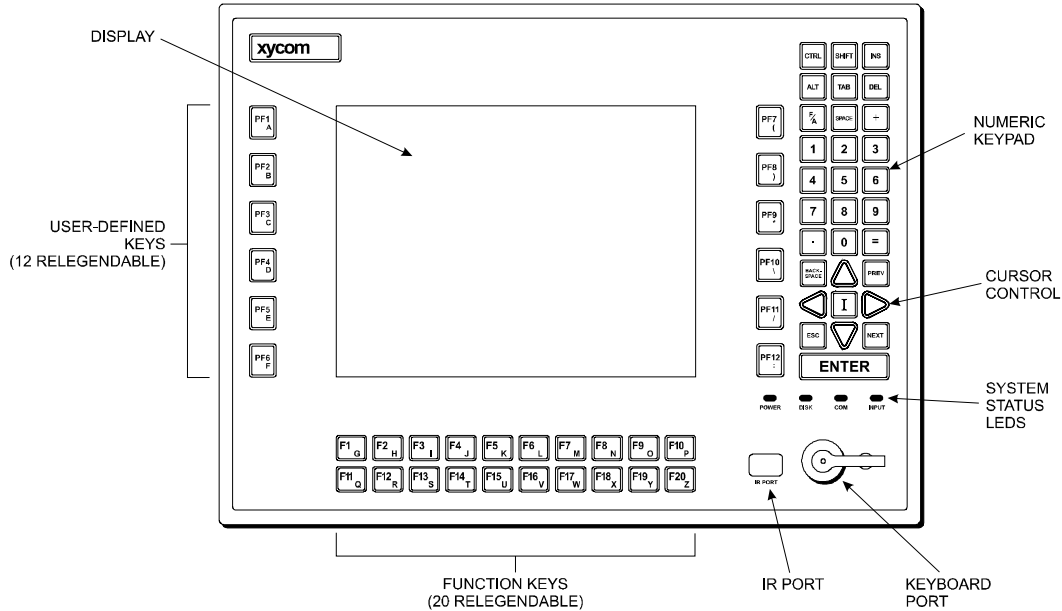

Figure 3-5. 3412KP Front Panel

Feature	Description
Display	The 3510KP/3512KP comes with a 10.4-inch (640 x 420) TFT flat panel display or a 12.1-inch SVGA (800 x 600) TFT flat panel display.
Diagnostic LEDs	In this application, the system status LEDs are not enabled.
Function and User-Defined Keys	These 32 relegendable function keys (64 using the F/A keys) provide easy access to familiar routines. (F/A keys can be used for alpha and symbol entry). See the <i>Customizing Keypad Inserts</i> section in this chapter for details on customizing your keypad inserts.
Numeric/Cursor Control Keypad	The purpose of data entry keypads are for entering data and moving the cursor.
PF10 Key (Keypad Configuration Key)	This key reconfigures your keypad.
Keyboard Port (3510KP/3512KP) (front access)	The 3510KP/3512KP provides both front and rear accessible PS/2 keyboard connectors. The front accessible connector is located on the lower right side of the front panel. The rear accessible connector is located on the side of the unit. Note: Only one keyboard port on the 3510/3512KP can be used at a time. Note: The installation of the touchscreen driver determines whether a second pointing device will function correctly. If you are using a mouse with a touchscreen, please review the <i>Touchscreen Driver Installation instructions</i> .

3408/3410/3412 I/O Panel



Floppy Drive Option
not Available with Windows CE

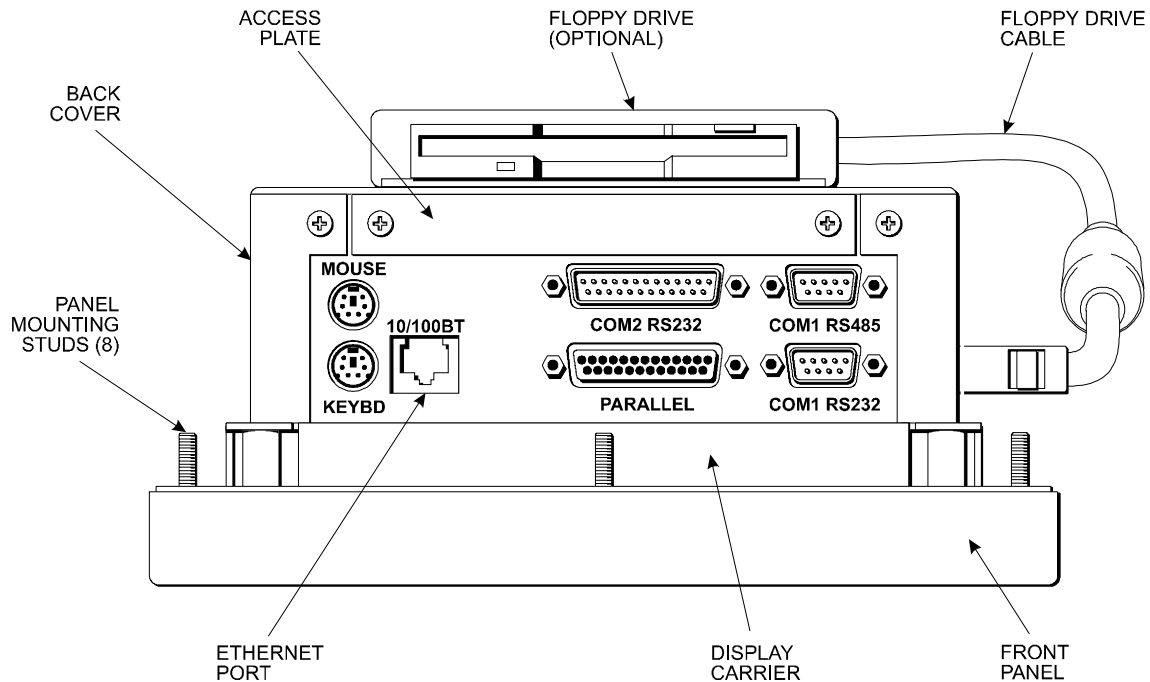

Figure 3-6. 3408/3410/3412 I/O Panel

Feature	Description
Parallel port (LPT1)	This port provides a standard PC-compatible interface to printers and other devices. Note: Printing is not supported by units with Windows CE..
COM1 port	COM1 is RS-232/485 compatible. The nine pin lower connector is RS/232. The upper connector is the RS/485 version of the same port. You can only use one of these connectors at a time since they are attached to the same logical port.
COM2 port	COM2 is dedicated to the IR port, the touchscreen controller, or the 25-pin connector. Only one option can be used at a time. An external pushbutton reset option is available. Consult the CPU board manual for the jumper that controls this option.
Ethernet Port	This port provides a 10BASE-T/100BASE-TX autosensing Ethernet connection.
Keyboard port	This port allows you to attach a PS/2-style keyboard.
Mouse port	This port allows you to attach a PS/2-style mouse. If the unit has a factory-installed touchscreen, this port may be unavailable for other use.

Note

A pointing device using the auxiliary port may not operate reliably in conjunction with an 84-key keyboard. Use of this combination is not recommended.

Warning

To maintain a safe condition, do *not* use an external keyboard or mouse port when the unit is operating in a hazardous environment.

Back Panel

Figure 3-7 illustrates the back panel on the 3408,3410 and 3412 units.

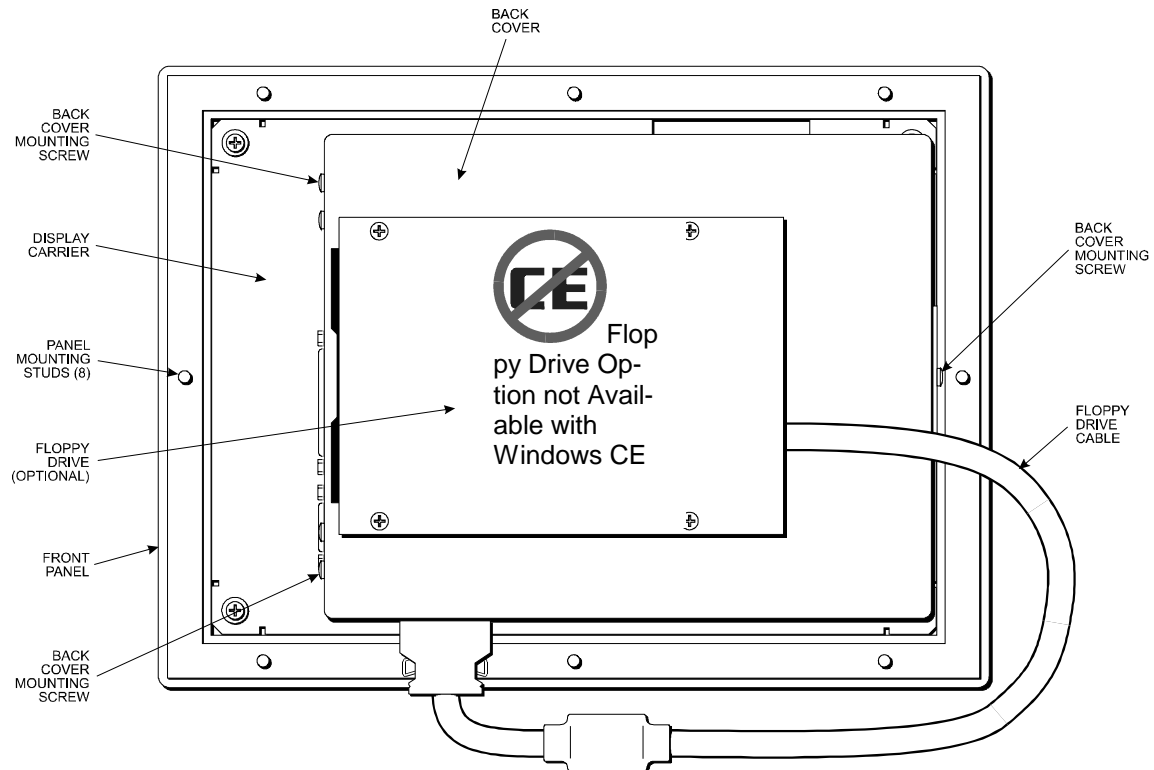



Figure 3-7. 3408/3410/3412 Back Panel

Warning

You must disconnect the power cable, floppy cable, and any other external cables connected to the unit before removing the back cover.

Feature	Description
Back cover	The back cover has five notches that slide into corresponding slots on the display carrier, as well as three screws that secure it to the unit.
External floppy disk drive (optional) 	You can install an external floppy disk drive to the back of the unit. It connects to the floppy connector on the bottom of the unit.
Panel mounting studs	There are studs on the back of the unit for panel mounting.

Power Panel

This section describes the power panels on the 3408, 3410 and 3412 units.

3408/3410 Power Panels

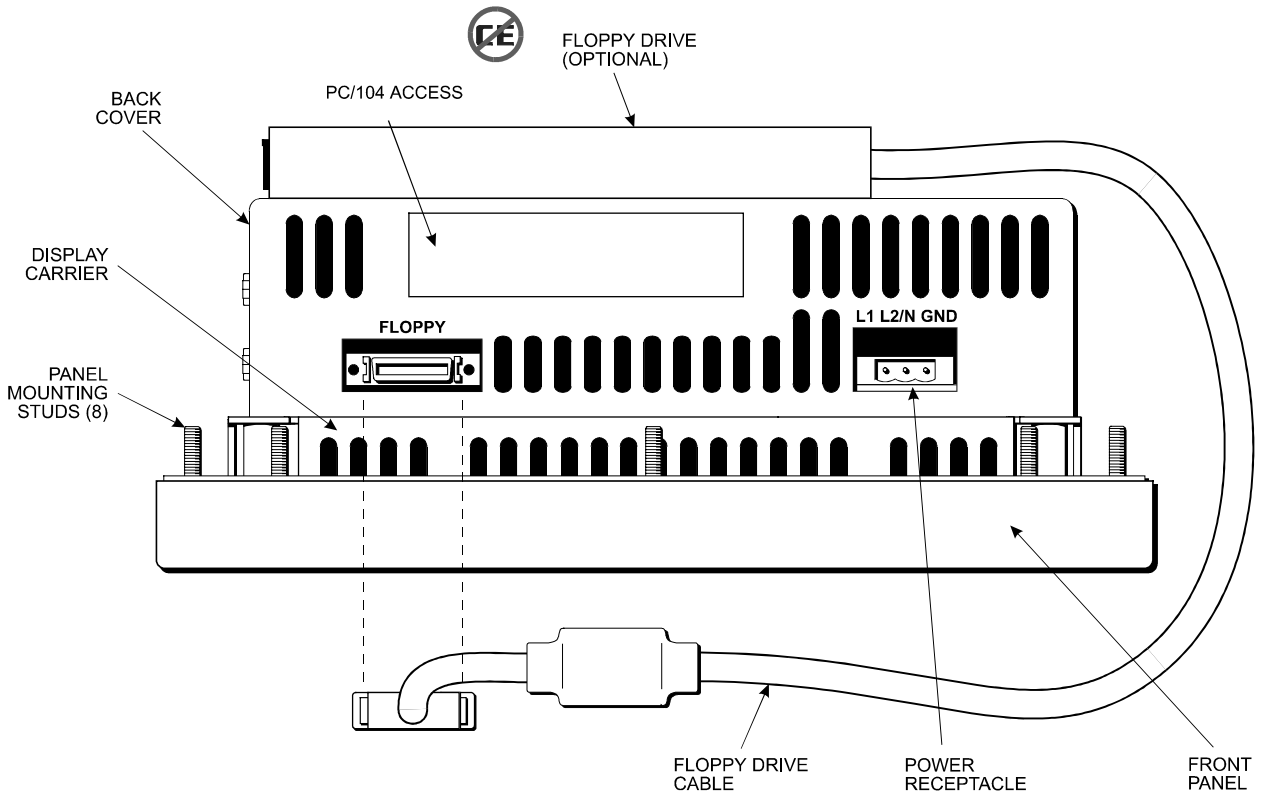

Figure 3-8. 3408 Power Panel

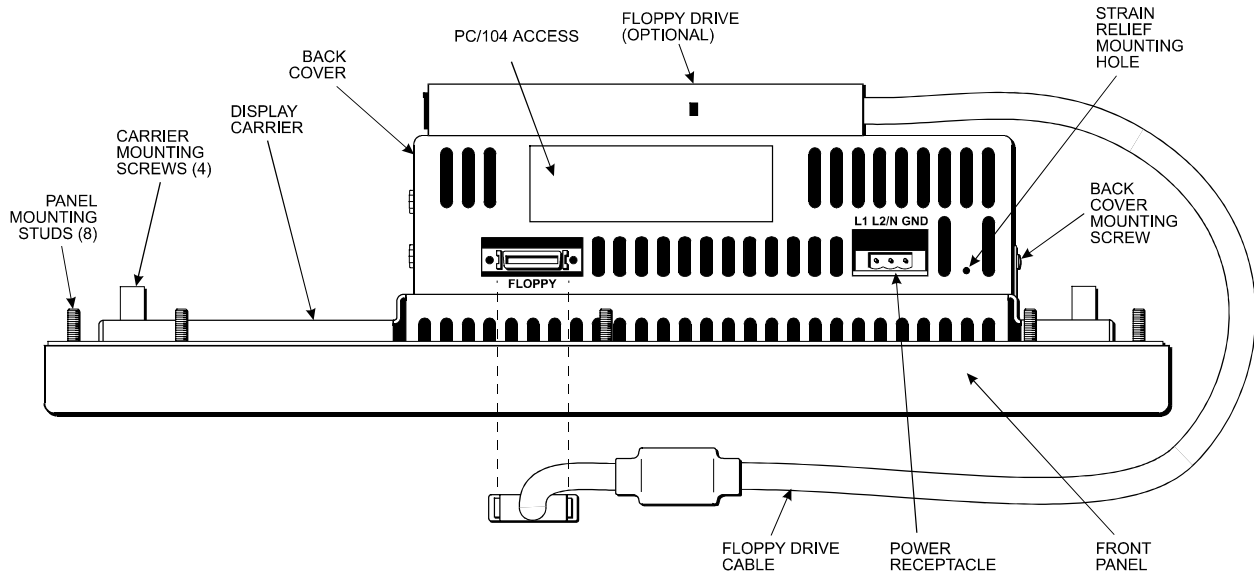

Figure 3-9. 3410/12 Power Panel

Feature	Description
Power connector	The power receptacle is a three-pin connector. Refer to Hazardous Location Installations section later in this chapter for special installation instructions.
External floppy drive connector	The 26-pin floppy drive connector lets you connect an optional external floppy drive.

Installing Internal Hardware Options

Warning

You must disconnect the power cable, floppy cable, and any other external cables connected to the unit before removing the back cover.

DRAM Single In-line Memory Modules (SIMMs)

You can order your system CPU factory-configured for many DRAM configurations. You can reconfigure DRAM capacity by changing the DRAM SIMMs on your CPU board.

The CHIP4e+ has one 72-pin in-line memory module (SIMM) site in which to add memory. Due to the CPU speed, DRAM access time should be 70 ns or less, and must be 60 ns to run with the fastest memory setting.

The CHIP4e+ can accommodate 4, 8, 16, 32, or 64 Mbytes of DRAM. You may use 1M x 32, 2M x 32, 4M x 32, 8M x 32, and 16M x 32 DRAM SIMM sizes.

The following tables list recommended DRAM manufacturers, along with the respective part numbers.

1M x 32 Part Numbers (4 Mbytes)

Manufacturer	Part Number	
	Non-EDO	EDO
Micron	MT8D132M-6	MT8D132M-6x
Reptron/PNY	N/A	ME10243208ES-60MT
Siemens	N/A	HYM3210055-60
Xycom	104273	

2M x 32 Part Numbers (8 Mbytes)

Manufacturer	Part Number	
	Non-EDO	EDO
Hitachi	N/A	HB56U232SB-6C
Micron	MT6D232M-6	MT6D232M-6x
Reptron/PNY	N/A	ME20483216ES-60MT
Siemens	N/A	HYM322005S-60
Xycom	104258	

4M x 32 Part Numbers (16 Mbytes)

Manufacturer	Part Number	
	Non-EDO	EDO
Hitachi	N/A	HB56V832SB-6BN
Micron	MT8D432M-6	MT8D432M-6x
NEC	N/A	MC-42800F32B-60
Xycom	104302	

8M x 32 Part Numbers (32 Mbytes)

Manufacturer	Part Number (EDO)
Micron	MT16D832M-6x
Xycom	106054

16M x 32 Part Numbers (64 Mbytes)

Manufacturer	Part Number (EDO)
Xycom	123514

The illustration below shows how to install DRAM SIMMS on the CHIP4e+.

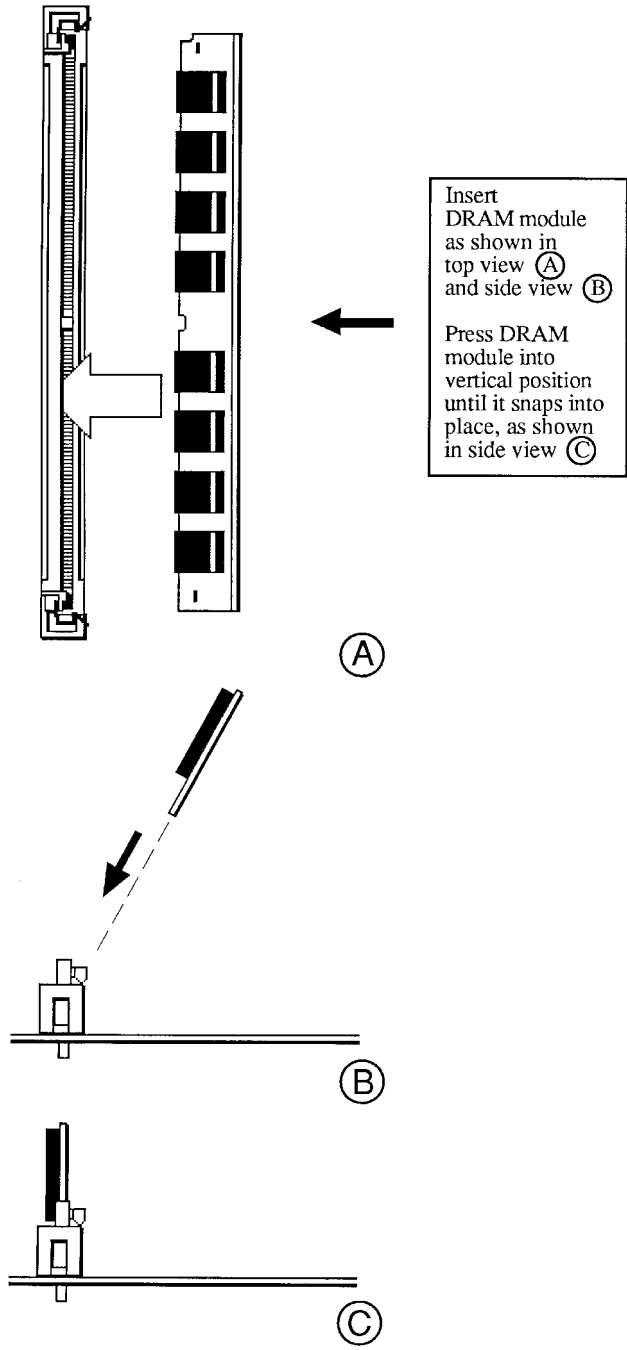

DRAM Installation

PC/104 Boards

Note

PC/104 cards must be installed and configured at the factory for units with the Windows CE operating system.

The PC/104 connector supports a 16-bit interface. The connectors are placed on the board so that PC/104 stack-through interface boards can be used.

Four standoffs are already attached to the CPU board. If you want to stack a second PC/104 card on the first, you need the four standoffs contained in the documentation kit.

Note

Installation of PC/104 cards may void EMC and hazardous locations compliance. This is a function of the PC/104 card design. It is the system integrator/user's responsibility to verify compliance before installing any given card.

Note

To prevent vibration failures, always use the locking screw to attach PC/104 cards.

Perform the following steps to install the PC/104 card:

1. Disconnect the power cable, floppy cable, and any other external cables.
2. On a protective surface, lay the unit on its front panel.
3. Unscrew the three back cover mounting screws (refer to Figure 3-7 for positioning information).
4. Slide the back cover toward the I/O panel, and lift off.
5. Attach the PC/104 card to the four preinstalled standoffs. If you want to install a second PC/104 card, you must attach the standoffs included in the documentation kit to the first PC/104 card.
6. If you need to connect the cards to something outside the unit, remove the access plate on the I/O panel. You can then pass cables through this area.

Installing External Hardware Options

This section explains how to install external hardware options.

External Floppy Drive



Note

To avoid corruption, do not attach the external floppy drive with a disk installed.

There are four screw holes on the back of the unit to mount an external floppy disk drive (9000-EXF). Refer to Figure 3-7.

Note

Make sure the floppy drive cable is able to reach the external floppy connector on the system before making the cutout.

Creating a Customized Logo

You may place a customized label on the unit. Figure 3-10 provides the dimensions and recommended requirements for a customized label.

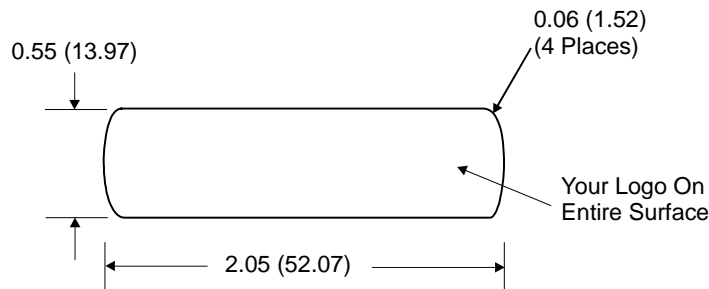

NOTE: All dimensions are in inches (mm)
RECOMMENDED MATERIAL: 0.007 (0.176) thick polyester with 3M #468 adhesive on far side

Figure 3-10. Logo Label Dimensions

Once you have created a customized label, place it over the “Xycom Automation” label (inside the recessed area).

Creating Customized Keypad Inserts

You can customize your 3408 and 3410 keypads with keypad inserts. The following figures provide the necessary dimensions and recommended requirements to create customized keypad inserts.

3408KP Keypad Inserts

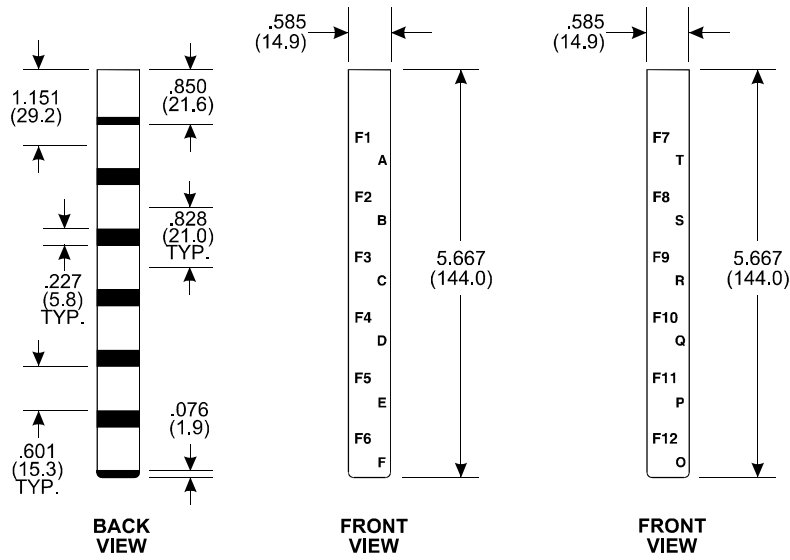

Note: All dimensions in inches (mm)
Material: .007 (.178) thick polyester

Figure 3-11. 3408KP F1-F12 Insert Dimensions

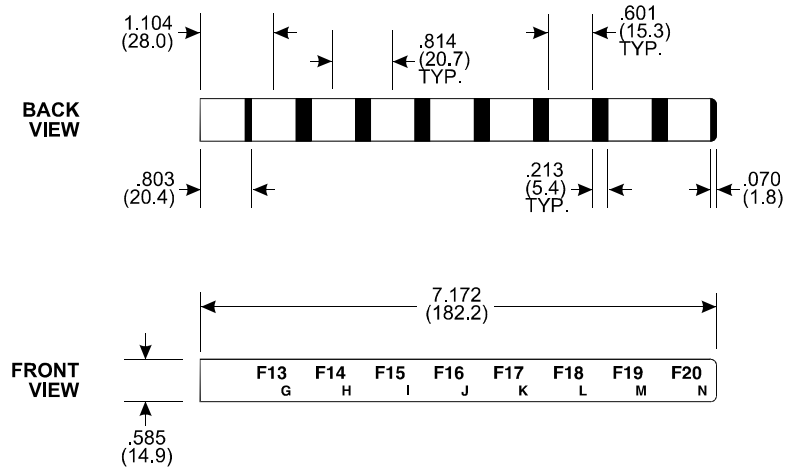

Note: All dimensions in inches (mm)
Material: .007 (.178) thick polyester

Figure 3-12. 3408KP F13-F20 Insert Dimensions

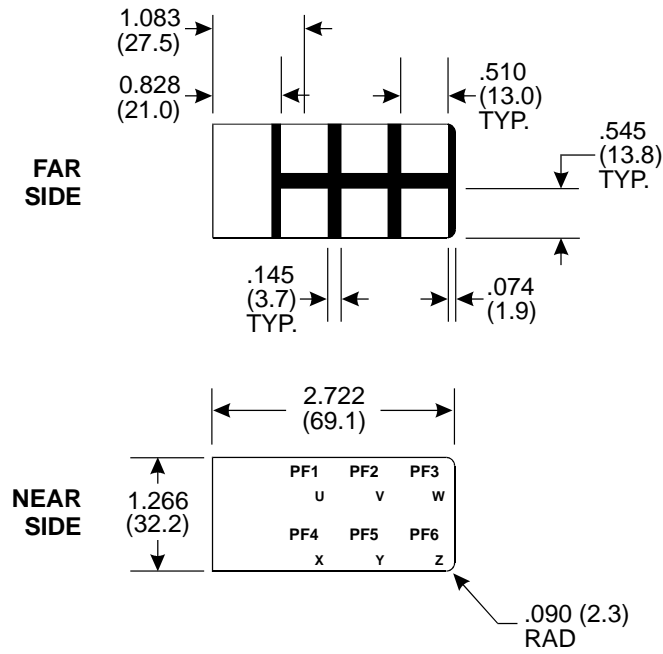

Note: All dimensions in inches (mm)
Material: .007 (.178) thick polyester

Figure 3-13. 3408KP Control Key Insert Dimensions

Figure 3-14 illustrates how to install the 3408KP keypad inserts.

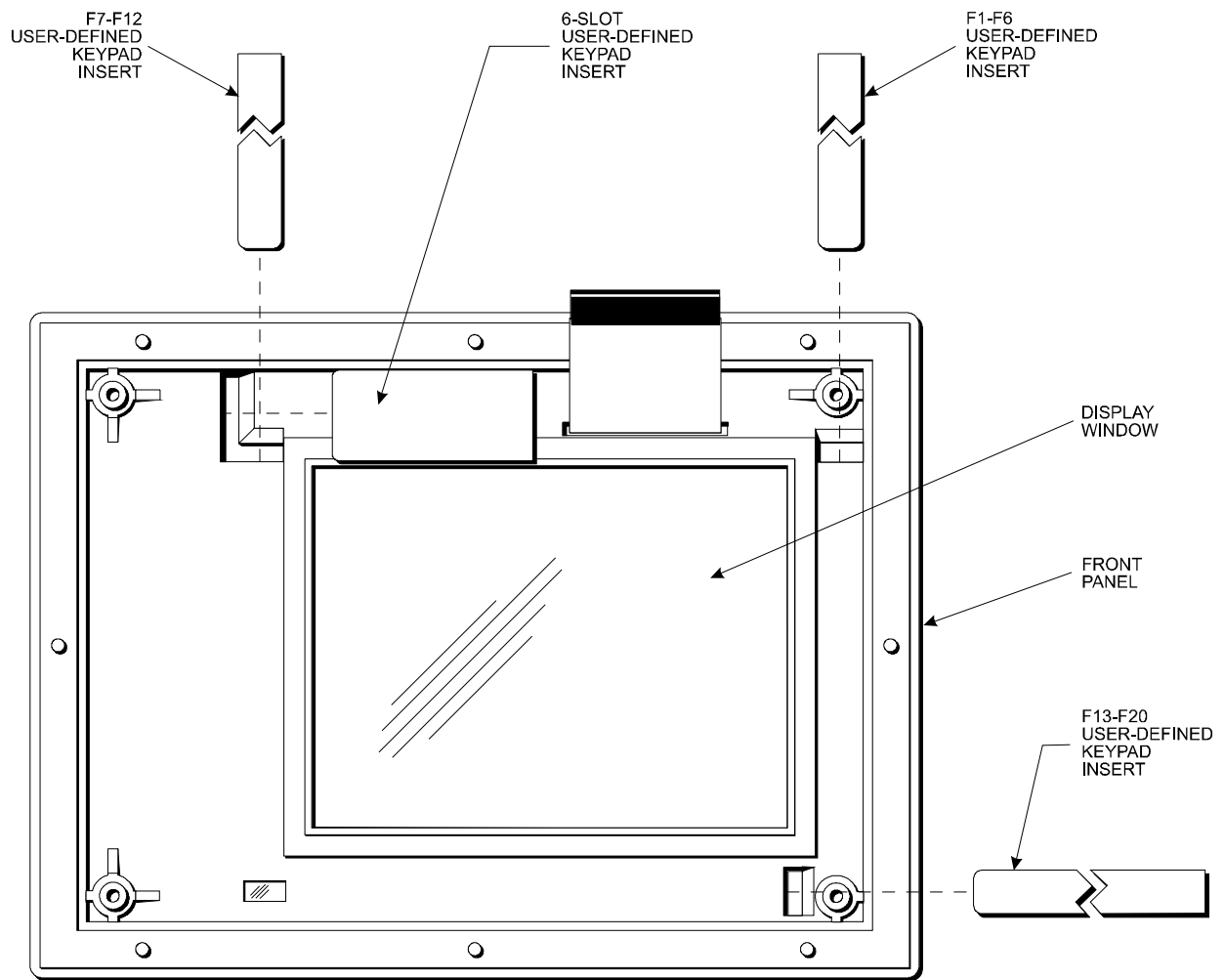
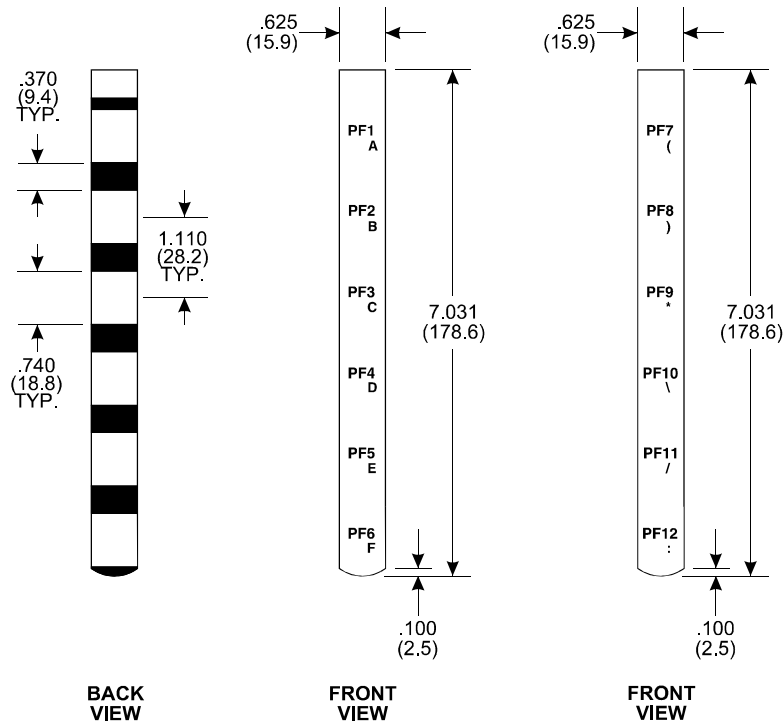

Figure 3-14. 3408KP Keypad Insert Installation

3410KP/3412KP Keypad Inserts



Note: All dimensions in inches (mm)
Material: .007 (.178) thick polyester

Figure 3-15. 3410KP/3412KP PF1-PF12 Insert Dimensions

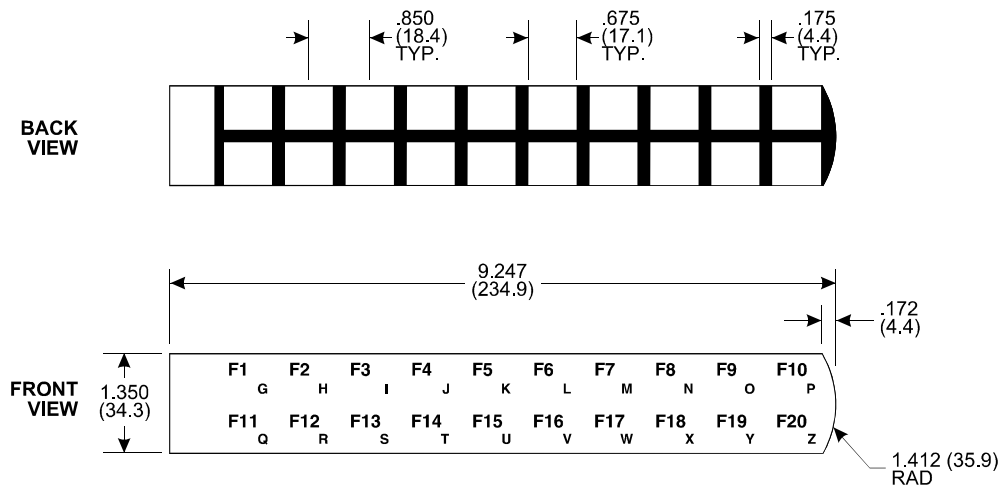
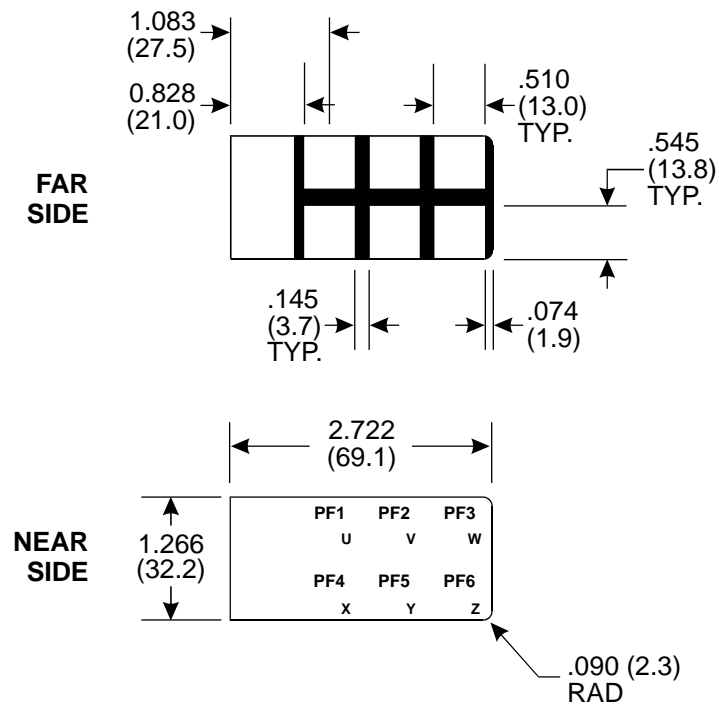

Figure 3-16. 3410KP/3412KP F1-F20 Insert Dimensions



Note: All dimensions in inches (mm)
 Material: .007 (.178) thick polyester

Figure 3-17. 3410KP/3412KP Control Key Insert Dimensions

Figure 3-18 illustrates how to install the 3410KP/3412KP keypad inserts.

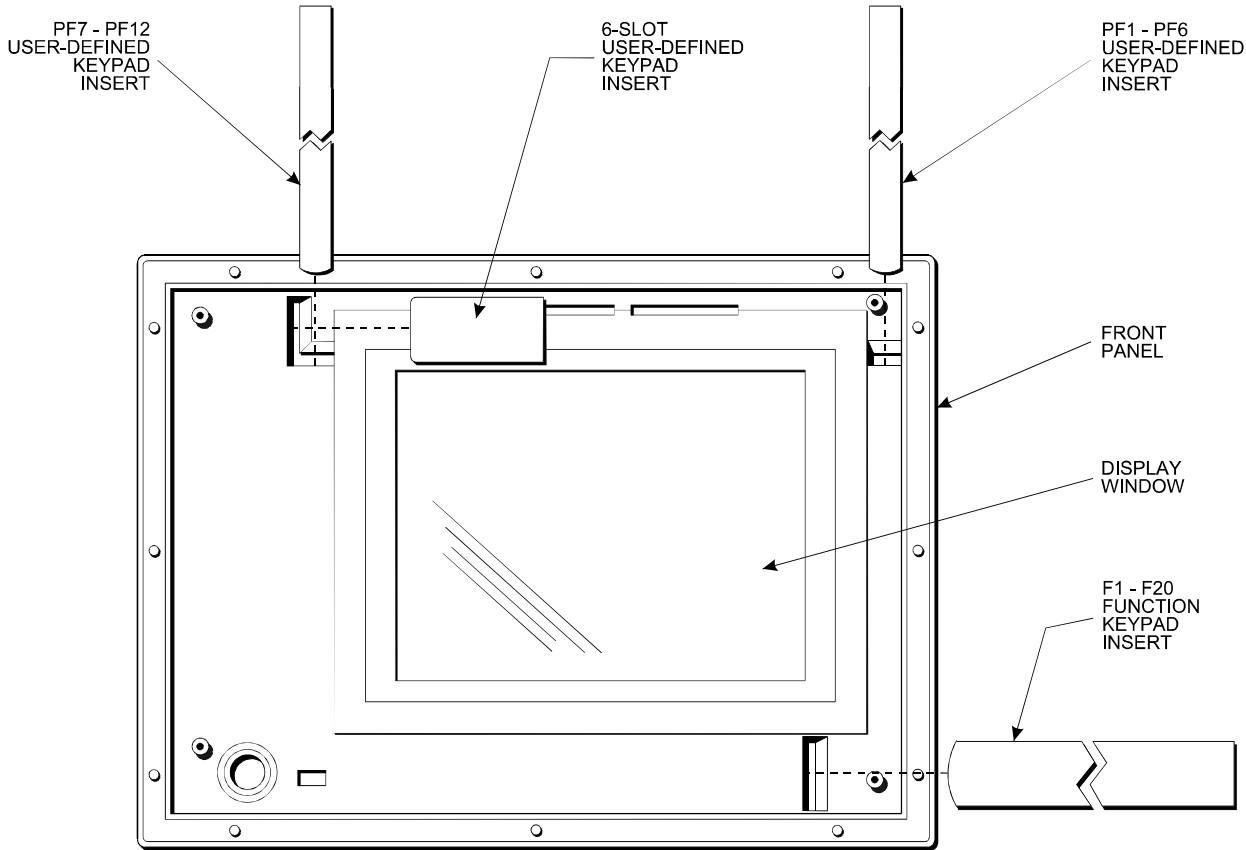

Figure 3-18. 3410KP/3412KP Keypad Insert Installation

Installing Operating Systems

The system comes with MS-DOS. You can also order the system preinstalled with Windows 95, or Windows NT or as an integrated workstation with Windows CE and industrial HMI software. Table 3-1 indicates the formats in which preinstalled operating systems are provided.

Table 3- 1. Operating System Formats

Operating Systems	Format
DOS	Disk
Windows 95	CD ROM
Windows NT	CD ROM

If you want to install a new operating system or re-install a current operating system, refer to the operating system’s manual for directions.

Note

An external CD-ROM drive may be required to load additional drivers on Windows 95 and Windows NT-equipped systems.

Installing Ethernet Drivers

If Windows 95 or Windows NT 4.0 is pre-installed on your system, Ethernet drivers are installed on your hard drive in the C:\netdrv directory.

Note

If you want to use Ethernet capabilities with Windows 95, your system must have BIOS revision level 1.1 or higher.

If MS-DOS is installed on your system, the Ethernet drivers are supplied on your hard drive in the C:\netdrv directory, but they are not installed.

To install the MS-DOS Ethernet drivers,

1. At the C: prompt, type “cd netdrv”.
2. Once the C:\netdrv path is specified, type “setup”.
3. Follow the on-screen instructions to complete installation.

Note

If you install Windows NT 4.0 on your system, the Ethernet drivers that are provided with Windows NT 4.0 do not work with the Ethernet controller on 3408/3410 units. You must use the drivers provided by Xycom Automation.

These drivers can be found on the Intel 558 Ethernet Drivers disk that ships with your system. Refer to the Msnt40.txt file in the A:\Info\Ms directory on this disk for installation information.

Consult the Info directory on the drivers disk for additional installation information. If Windows CE is on your system, you can not change the currently installed and configured drivers.

Installing Video Drivers

Video drivers and the expansion utilities are on the disk included with the documentation kit as well as on the hard drive.

The video drivers are in the following directories for systems with DOS:

C:\VGA\C&T550\WIN95
C:\VGA\C&T550\WINNT
C:\VGA\C&T550\WINCE
C:\VGA\C&T\DOS\UTILITIES

The appropriate drivers are copied to the hard drive under C:\VIDDRV for systems with Windows 95 or Windows NT installed.

Using a Touchscreen

Xycom Automation's touchscreen complies with environmental specifications and maintains a NEMA 4 seal when panel mounted. It remains operational even after 30 million touches.

Note

These touchscreen instructions do not apply to units with the Windows CE operating system. To calibrate the touchscreen, refer to the Quick-start guide for your Windows CE workstation.

Installing Touchscreen Drivers

Depending upon the date of purchase, the Xycom Automation unit will have one of two possible touchscreen controllers:

- The Microtouch Controller P/N 114084
- The Xycom Controller P/N 140554

These controllers function similarly. However, the following sections require attention to the type of controller installed.

Microtouch Controller

If a touchscreen is factory installed, you will receive a disk with MS-DOS and Windows 95 touchscreen drivers. If Windows 95 is preinstalled on your system with a touchscreen, the touchscreen driver has already been installed. If you ordered the Windows NT option, a copy of the driver is provided on disk, as well as on the hard drive (c:\touchdrv). You must purchase touchscreen drivers for OS/2 (3408-DRVOS/2) separately.

The Windows 95 touchscreen driver supports the COM2 and mouse ports. The Windows NT touchscreen driver *only* supports COM2.

If you change the operating system, you must install the corresponding touchscreen driver software. Refer to the touchscreen manual for instructions.

Xycom Controller

If a touchscreen is factory installed, you will receive a CD with MS-DOS and Windows touchscreen drivers.

If you change the operating system, you must install the corresponding touchscreen driver software. Refer to the touchscreen manual for instructions.

Specifying a Touchscreen Port

Warning

You must disconnect the power cable, floppy cable, and any other external cables connected to the unit before removing the back cover.

Depending upon the date of purchase, the Xycom Automation unit will have one of two possible touchscreen controllers:

- The Microtouch Controller P/N 114084
- The Xycom Controller P/N 140554

These controllers function similarly. However, the following sections require attention to the type of controller installed.

Microtouch Controller

Note

If the touchscreen is factory-installed along with MS-DOS or Windows 95, the touchscreen is configured for the mouse port, making the mouse port unavailable for other use. If Windows NT is factory installed, the touchscreen is configured for COM2, making COM2 unavailable for other use.

Perform the following steps to reconfigure the port used by the touchscreen controller:

1. Disconnect the power cable and other external cables and remove the back cover as described in the *PC/104 Boards* section earlier in this chapter.
2. Remove the touchscreen controller card. Figure 3-19A shows the touchscreen controller card and its jumper set.

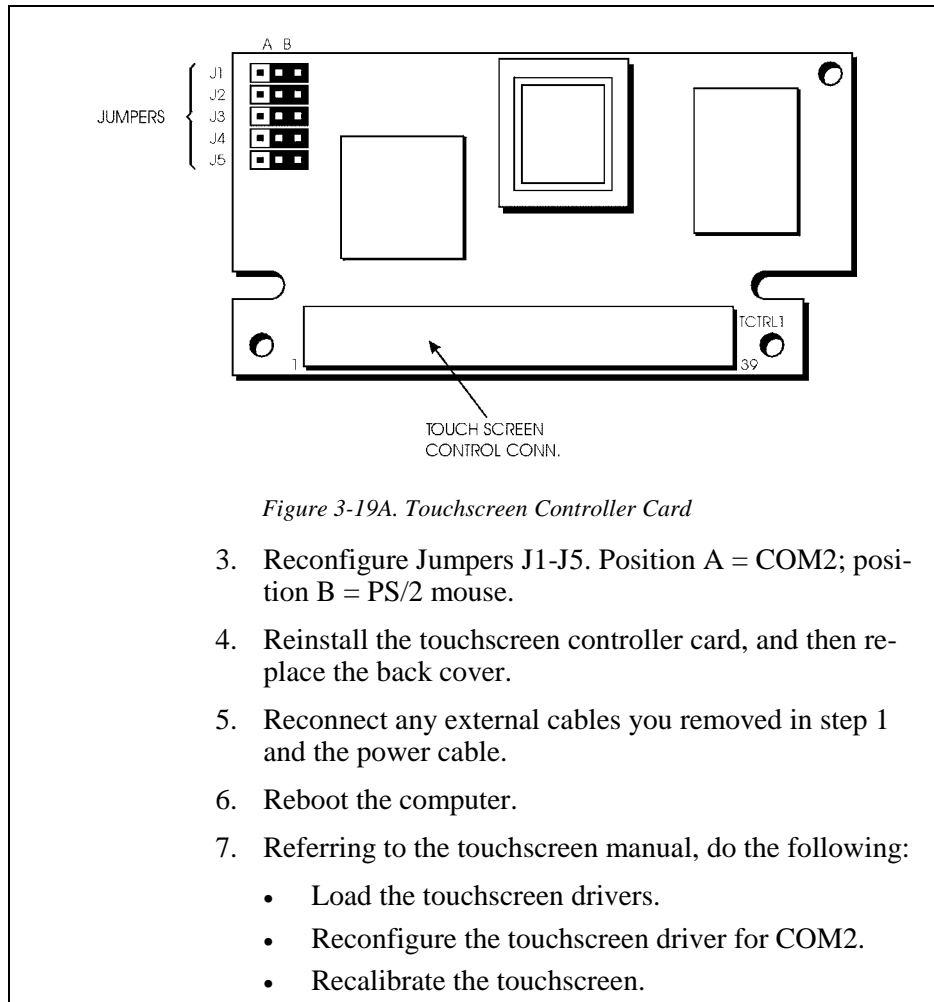

Figure 3-19A. Touchscreen Controller Card

3. Reconfigure Jumpers J1-J5. Position A = COM2; position B = PS/2 mouse.
4. Reinstall the touchscreen controller card, and then replace the back cover.
5. Reconnect any external cables you removed in step 1 and the power cable.
6. Reboot the computer.
7. Referring to the touchscreen manual, do the following:
 - Load the touchscreen drivers.
 - Reconfigure the touchscreen driver for COM2.
 - Recalibrate the touchscreen.

Xycom Controller

Perform the following steps to reconfigure the port used by the touchscreen controller:

1. Disconnect the power cable and other external cables and remove the back cover as described in the *PC/104 Boards* section earlier in this chapter.
2. Remove the touchscreen controller card Figure 3-19B shows the touchscreen controller card and its jumper set.

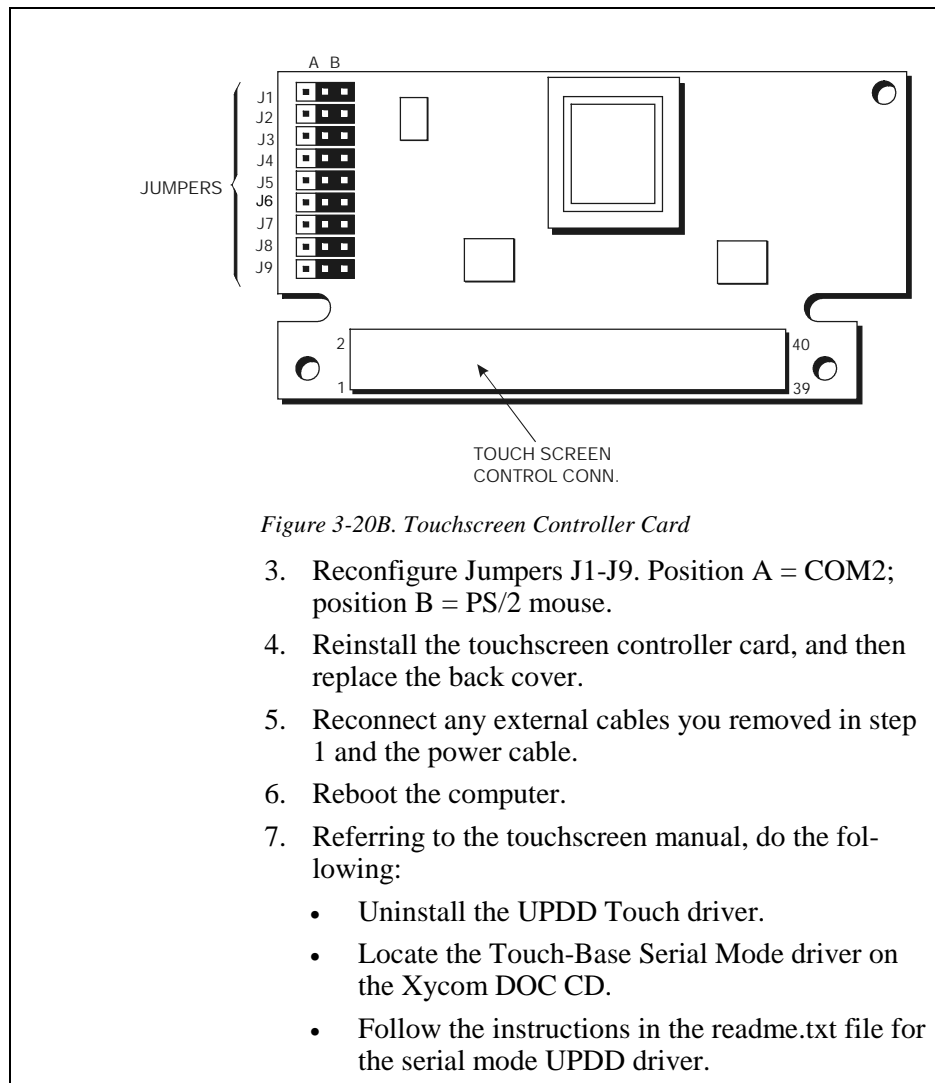

Figure 3-20B. Touchscreen Controller Card

3. Reconfigure Jumpers J1-J9. Position A = COM2; position B = PS/2 mouse.
4. Reinstall the touchscreen controller card, and then replace the back cover.
5. Reconnect any external cables you removed in step 1 and the power cable.
6. Reboot the computer.
7. Referring to the touchscreen manual, do the following:
 - Uninstall the UPDD Touch driver.
 - Locate the Touch-Base Serial Mode driver on the Xycom DOC CD.
 - Follow the instructions in the readme.txt file for the serial mode UPDD driver.

Calibrating the Touchscreen

Depending upon the date of purchase, the Xycom Automation unit will have one of two possible touchscreen controllers:

- The Microtouch Controller P/N 114084
- The Xycom Controller P/N 140554

These controllers function similarly. However, the following sections require attention to the type of controller installed.

Microtouch Controller

If you need to recalibrate the touchscreen, refer to the sections in the touchscreen manual that explain calibrating the touchscreen and using the diagnostic utility.

Note

The touchscreen and controller are a matched pair calibrated at the factory.

Xycom Controller

If you need to recalibrate the touchscreen, run the Pointer Devices Control Panel applet. Select Help for details about calibrating. For best results, use the 25 point calibration setting with Start In At set to 0.

You need to calibrate the touchscreen if

- The cursor does not follow the movement of your finger or pen
- You adjust the size of the video image or change the video mode

Creating a Power Cable

This section describes how to create both an AC and a DC power cable.

AC Power Cable

You must create an AC power cable to supply power to units with AC power supplies. You will need the following materials:

- A three-position power connector (supplied)
- A braid/foil shielded power cable, terminated at power source end, with three 18 (1.0 mm), 16 (1.3 mm), or 14 (1.6 mm) AWG solid or stranded copper wire, rated 80° C or better.

Perform the following steps to create the cable:

1. Cut the wire cable to the desired length.
2. Strip 0.25-inch (6 mm) of insulation from the end of the conductor wire. No bare wire should be exposed when the cable is connected to the workstation.
3. Tin the wire ends with solder if using stranded wire. This will keep the wire from fraying.

Warning

When inserting the wire ends of the power cable into the block plug, be sure there is no exposed wire. Trim the wire ends of the cable or cut a new cable if necessary.

4. Insert the three wire ends of the power cable into the three holes of the block plug. Insert the Protective Earth GND ground, L1, and L2/N wires into the corresponding holes, as shown in Figure 3-21. Be sure that no bare wires are exposed.

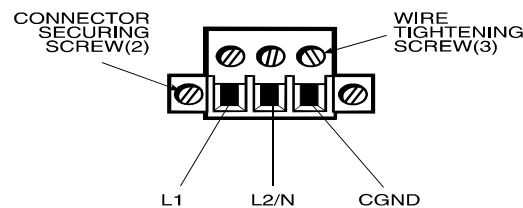

Figure 3-21. AC Power Connector

5. Tighten the three screws above the wires to hold them firmly in place.

Warning

Never tighten the three screws of the block plug when the cable is connected to a power source. The screws are conductive and have full contact with the cable wire.

6. Use a cable clamp and #6-32 screw (provided) to secure and provide strain relief to the power cable. When installing the power cable to the unit, use the securing screws on each side of the plug. This strain relief is mandatory for hazardous locations compliance.

Warning

Be sure to completely loosen the two securing screws on the plug when disconnecting the power cord from the unit.

DC Power Cable

You must create a DC power cable to supply power to units with DC power supplies. You will need the following materials:

- A three-position power connector (supplied)
- A braid/foil shielded power cable with three 18 (1.0 mm), 16 (1.3 mm), or 14 (1.6 mm) AWG solid or stranded copper wire, rated 80° C or better.

Perform the following steps to create the cable:

1. Cut the wire cable to the desired length.
2. Strip 0.25-inch (6 mm) of insulation from the end of the conductor wire. No bare wire should be exposed when the cable is connected to the workstation.
3. Tin the wire ends with solder if using stranded wire. This will keep the wire from fraying.

Warning

When inserting the wire ends of the power cable into the block plug, be sure there is no exposed wire. Trim the wire ends of the cable or cut a new cable if necessary.

4. Insert the three wire ends of the power cable into the three holes of the block plug. Insert the Protective Earth GND ground, + (positive), and - (return) wires into the corresponding holes, as shown in Figure 3-22. Be sure that no bare wires are exposed.

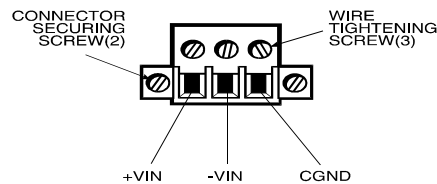

Figure 3-22. DC Power Connector

5. Tighten the three screws above the wires to hold them firmly in place.

Warning

Never tighten the three screws of the block plug when the cable is connected to a power source. The screws are conductive and have full contact with the cable wire.

6. Use the aluminum cable clamp (provided) to terminate the DC cable shield and provide strain relief. The aluminum cable clamp is designed to accommodate cable with 1/4-inch (6.4 mm) O.D.
7. The DC cable shield must be terminated to chassis ground (PE) at the 3408 end. A pigtail termination will not provide enough EMI suppression in those installations where the DC cable exits a metal enclosure.

To terminate the braided cable shield, the braid must be dressed back over the cable insulation 1/2 inch (13 mm). The aluminum clamp must then be placed over the braid/insulation. Use the #6-32 screw (provided) to secure the clamp to the chassis in

the female pem located on the side of the power connector opening. When installing the power cable to the unit, use the securing screws on each side of the plug.

Warning

Be sure to completely loosen the two securing screws on the plug when disconnecting the power cord from the unit.

Installing the System into a Panel

The system's rugged design allows it to be installed in most industrial environments. The system is generally placed in a NEMA 4/4X/12 enclosure to protect against contaminants such as dust, moisture, etc. Metal enclosures also help minimize the effects of electro-magnetic radiation that nearby equipment can generate.

System Power

Using isolation transformers on the incoming AC power line to the system is always a good practice. An isolation transformer is especially desirable in cases in which heavy equipment is likely to introduce noise onto the AC line. The isolation transformer can also serve as a step-down transformer to reduce the incoming line voltage to a desired level. The transformer should have a sufficient power rating (units of volt-amperes) to supply the load adequately.

Proper grounding is essential to all safe electrical installations. Refer to the relevant federal, state/provincial, and local electric codes which provide data such as the size and types of conductors, color codes and connections necessary for safe grounding of electrical components. The code specifies that a grounding path must be permanent (no solder), continuous, and able to safely conduct the ground-fault current in the system with minimal impedance (minimum wire required is 18 AWG, 1 mm).

Observe the following practices:

- Separate ground wires (P.E. or Protective Earth) from power wires at the point of entry to the enclosure. To minimize the ground wire length within the enclosure, locate the ground reference point near the point of entry for the plant power supply.
- All electrical racks or chassis and machine elements should be Earth Grounded in installations where high levels of electrical noise can be expected. The rack/chassis should be grounded with a ground rod or attached to a nearby Earth structure such as a steel support beam. Connect each different apparatus to a single Earth Ground point in a "star" configuration with low impedance cable. Scrape away paint and other nonconductive material from the area where a chassis makes contact with the enclosure. In addition to the ground connection made through the mounting bolt or stud, use a one-inch metal braid or size #8 AWG wire to connect between each chassis and the enclosure at the mounting bolt or stud.

Excessive Heat

The systems withstand temperatures from 0° to 50° C. They are cooled by convection, in which a vertical column of air is drawn in an upward direction over the surface of its components. To keep the temperature in range, the cooling air at the base of the system must not exceed 50° C. Allocate proper spacing between internal components installed in the enclosure.

When the air temperature is higher than the specified maximum in the enclosure, use a fan or air conditioner to lower the temperature.

Electrical Noise

Electrical noise is seldom responsible for damaging components, unless extremely high energy or high voltage levels are present. However, noise can cause temporary malfunctioning which can result in hazardous machine operation in certain applications. Noise may be present only at certain times, may appear at widely-spread intervals, or in some cases may exist continuously.

Noise commonly enters through input, output, and power supply lines and may also be coupled through the capacitance between these lines and the noise signal carrier lines. This usually results from the presence of high voltage or long, close-spaced conductors. When control lines are closely spaced with lines carrying large currents, the coupling of magnetic fields can also occur. Use shielded cables to help minimize noise. Potential noise generators include switching components, relays, solenoids, motors, and motor starters.

Refer to the relevant Federal, State/Provincial, and local electric codes, which provide data such as the size and types of conductors, color codes and connections necessary for safe grounding of electrical components. It is recommended that high- and low-voltage cabling be separated and dressed apart. In particular, AC cables and switch wiring should not be in the same conduit with all communication cables.

Line Voltage Variation

The power supply section of the unit is built to sustain line fluctuations of 90-250 VAC and still allow the system to function within its operating margin. As long as the incoming voltage is adequate, the power supply provides all the logic voltages necessary to support the processor, memory, and I/O.

When the installation is subject to unusual AC line variations, use a constant voltage transformer to prevent the system from shutting down too often. However, a first step toward the solution of the line variations is to correct any possible feed problem in the distribution system. If this correction does not solve the problem, use a constant voltage transformer.

The constant voltage transformer stabilizes the input voltage to the systems by compensating for voltage changes at the primary in order to maintain a steady voltage at the secondary. When using a constant voltage transformer, check that the power rating is sufficient to supply the unit.

Mounting Considerations

Once you have established a location for the unit, consider the following when selecting an enclosure:

- Select a NEMA-rated enclosure, and place the unit to allow easy access to the system ports.
- Account for the unit's depth when choosing the depth of the enclosure.
- Provide a NEMA 4 seal by mounting the unit in an approved enclosure that has a 14 gauge (0.075"/1.9 mm thick) steel or (0.125"/3.2 mm thick) aluminum front face.
- Mount the unit in an upright position.
- Place the unit at a comfortable working level.
- Consider locations of accessories such as AC power outlets and lighting (interior lighting and windows) for installation and maintenance convenience.
- Prevent condensation by installing a thermostat-controlled heater or air conditioner.
- Avoid obstructing the air flow to allow for maximum cooling.
- Place any fans or blowers close to the heat-generating devices. If using a fan, make sure that outside air is not brought inside the enclosure unless a fabric or other reliable filter is used. This filtration prevents conductive particles or other harmful contaminants from entering the enclosure.
- Do not select a location near equipment that generates excessive electromagnetic interference (EMI) or radio frequency interface (RFI) (equipment such as high-power welding machines, induction heating equipment, and large motor starters).
- Do not place incoming power line devices (such as isolation or constant voltage transformers, local power disconnects, and surge suppressers) near the system. The proper location of incoming line devices keeps power wire runs as short as possible and minimizes electrical noise transmitted to the unit.
- Make sure the location does not exceed the unit's shock, vibration, and temperature specifications (refer to Appendix A for specifications).
- Install the unit in the panel in such a way as to ensure that it does not cause a hazard from uneven mechanical loading.
- Incorporate a readily accessible disconnect device in the fixed wiring on permanently connected equipment.
- Avoid overloading the supply circuit.

Mounting the Unit

Once the conditions in the preceding sections have been met, perform the following steps to mount the unit:

1. Locate a position for your system that meets the specifications required (see previous sections and Appendix A).
2. Create a panel cutout. Refer to the dimensions in Figures 3-20 through 3-23.
3. Make sure the area around the cutout is clean and free from metal burrs.
4. Install the unit.

5. Attach one end of the power cord to the power receptacle and the other end to a properly grounded 90-250 VAC, 50-60 Hz or 24 VDC (on DC units) outlet, whichever applies. (See *Hazardous Location Installations* later in this chapter for more information.)
6. Implement the proper grounding techniques. Establish a ground path from the unit chassis to the enclosure chassis. A 6-32 threaded ground point hole is provided on the bottom panel of the unit.
7. Tighten the eight #8-32 nuts on 3408 units to 16 inch-pounds (1.8 Newton-meters; 18 Kgf cm). Tighten the twelve #10-32 nuts on 3410 units to 25 inch-pounds (2.8 Newton-meters; 28 Kgf cm).
8. Turn on power to the unit. The system will boot up to the operating system installed. Install application software via a floppy drive, the IR port, or a network.

9. System Cutout Dimensions

This section provides system cutout dimensions.

3408T Cutout Dimensions

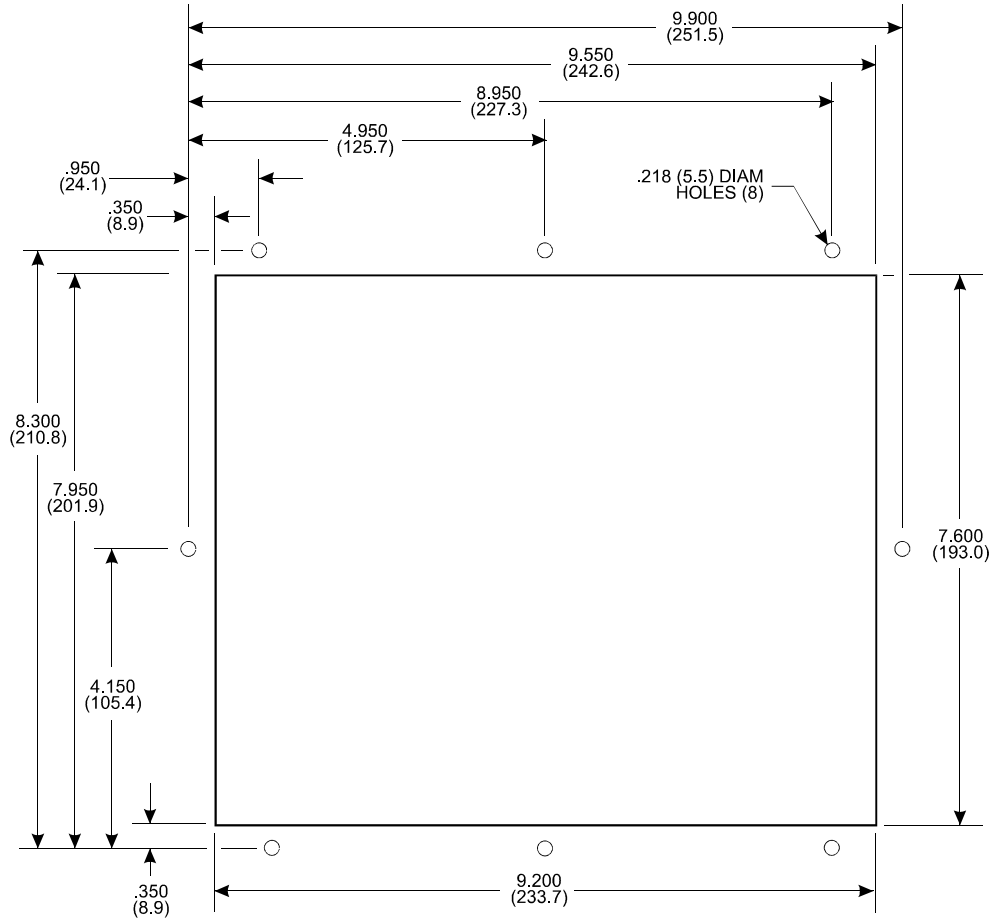

- Notes:
- All dimensions in inches (mm)
 - Torque 8-32 mounting nuts to 16 inch-lbs. (1.8 Nm) (18 Kgf cm)

Figure 3-23. 3408T System Cutout Dimensions

3408KP Cutout Dimensions

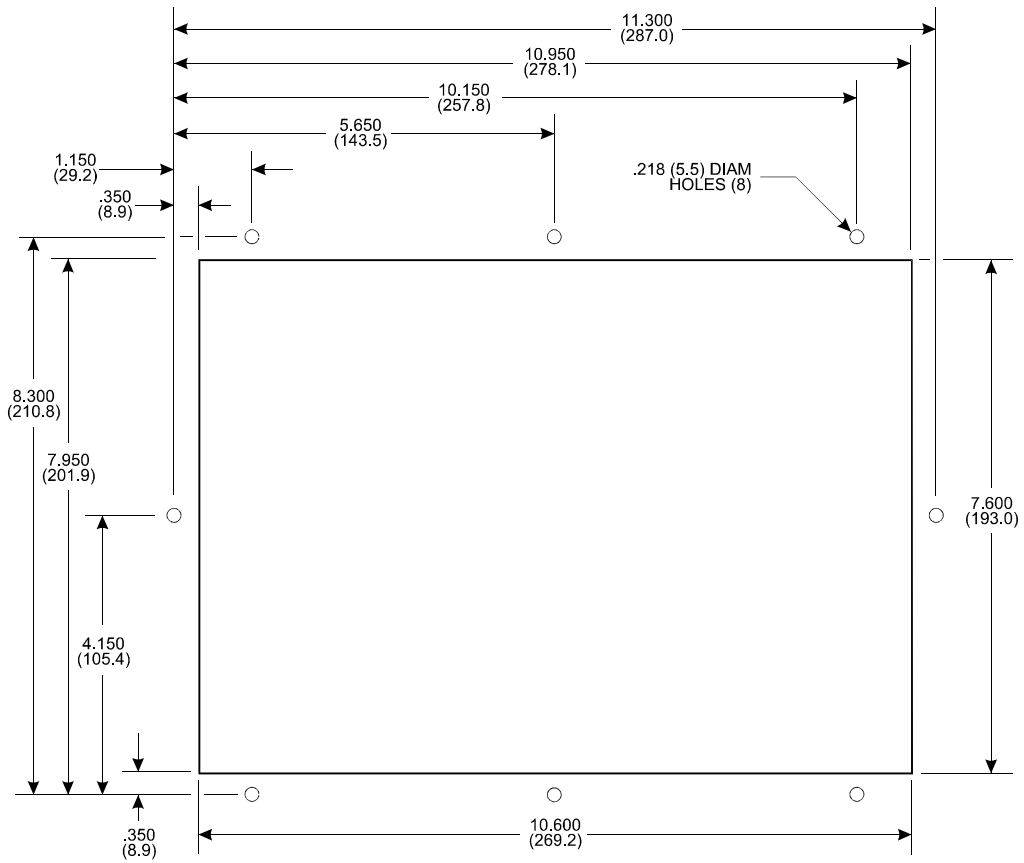

- Notes:
- All dimensions in inches (mm)
 - Torque 8-32 mounting nuts to 16 inch-lbs. (1.8 Nm) (18 Kgf cm)

Figure 3-24. 3408KP System Cutout Dimensions

3410T/3412T Cutout Dimensions

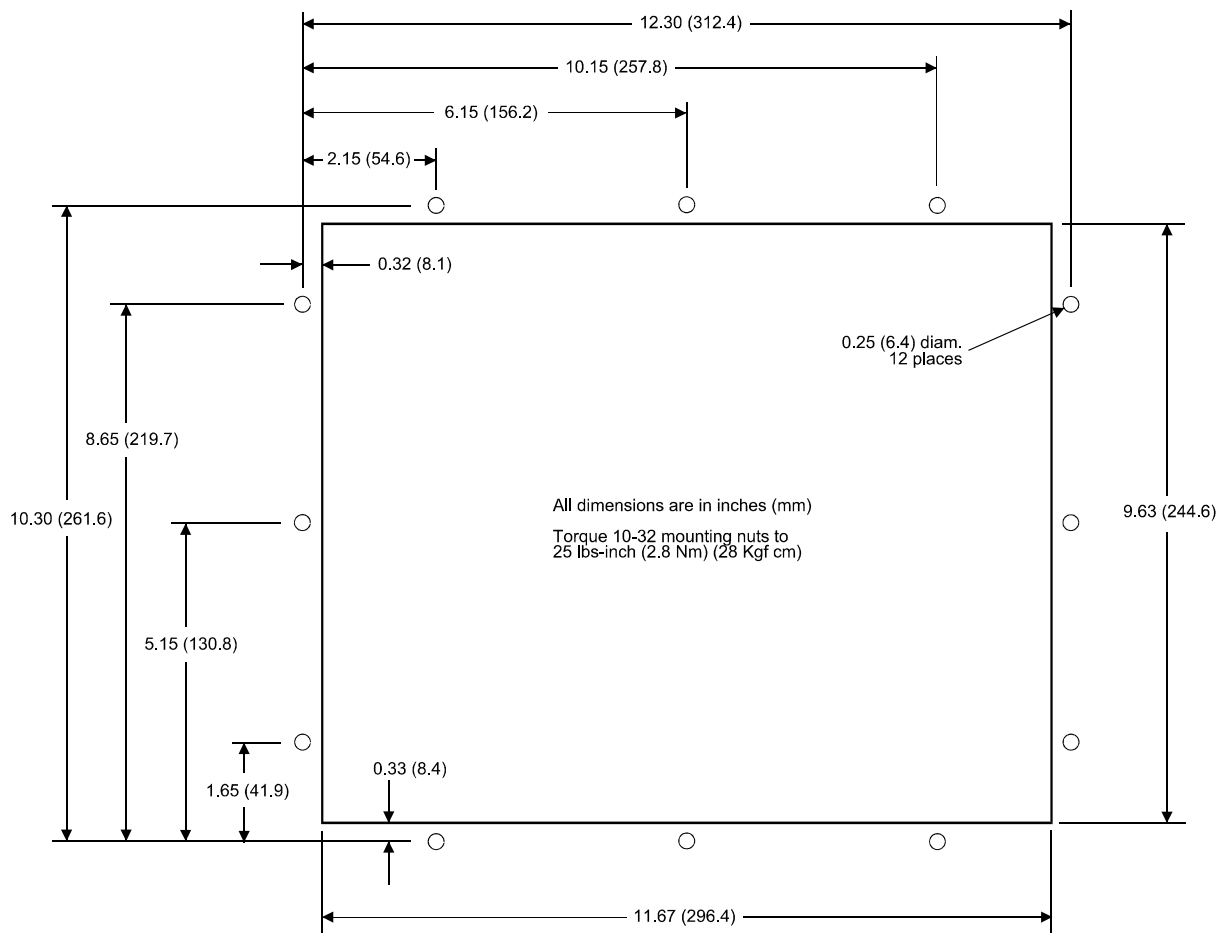

Figure 3-25. 3410/12T System Cutout Dimensions

3410KP/3412KP Cutout Dimensions

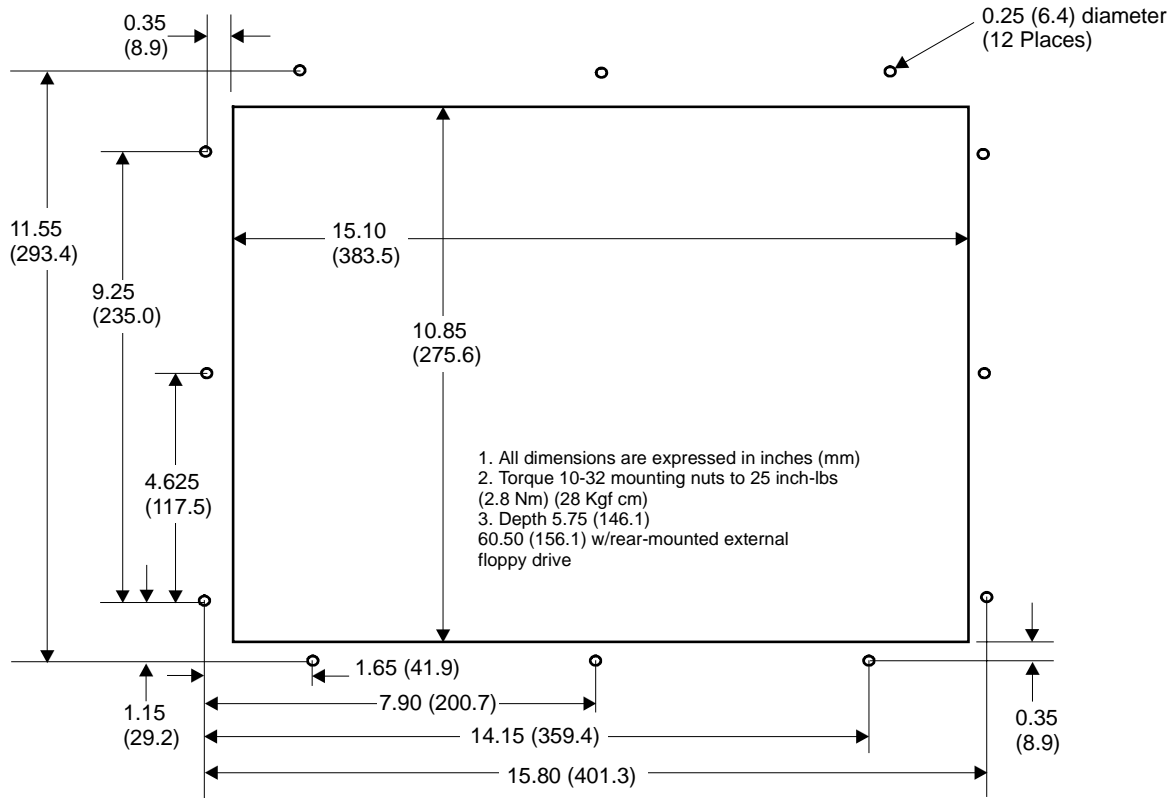

Figure 3-26. 3410/12KP System Cutout Dimensions

Power Supply

The standard systems ship with an AC power supply; a 24 VDC power supply is optional. This section provides specifications for both AC and DC power supplies.

AC Power Supply

The AC power supply provides 90-250 VAC, 50-60 Hz (autosensing), 1 A maximum at 90 VAC with 35 watts of output throughout the system's temperature range.

DC Power Supply

The DC power supply accepts +24 VDC input voltage for applications requiring DC input power. The factory-installed power supply module provides +5 V, +12 V, and -12 V outputs.

Electrical specifications for the power supply are 18 to 36 VDC, 2.5 A maximum at 18 volts.

Expansion Power

Table 3-2 lists the available power from both the AC and DC power supplies.

Table 3- 2. Available Expansion Power

Voltage	CHIP4e+ Available Current
+5 V	.80 A
+12 V	.25 A
- 12 V	.25 A

Total not to exceed 6 W

Hazardous Location Installations

Xycom Automation designed the systems to meet Class I, Division 2 Hazardous Location application requirements. Division 2 locations are locations that are normally non-hazardous, but could potentially become hazardous should accidents expose the area to flammable vapors, gases, or combustible dusts.

These systems have been designed as non-incendiary devices. They are not intrinsically safe and should never be operated within a Division 1 (normally hazardous) location when installed as described here. Nor should any peripheral interface device attached to these systems be located within Division 1 locations unless approved and/or certified diode barriers are placed in series with each individual signal and DC power line. Any such installations are beyond the bounds of Xycom Automation design intent. Xycom Automation accepts no responsibility for installations of this equipment or any devices attached to this equipment in Division 1 locations.

Note

When adding cards to the system, the user must ensure that they meet operating conditions for Class I, Division 2 hazardous locations.

It is the customer's responsibility to ensure that the product is properly rated for the location. If the intended location does not presently have a Class, Division, and Group rating, then users should consult the appropriate authorities having jurisdiction to determine the correct rating for that hazardous location.

In accordance with federal, state/provincial, and local regulations, all hazardous location installations should be inspected by the authority having jurisdiction, prior to use. Only technically qualified personnel should install, service, and inspect these systems.

Warning

Suitable for use in Class I, Division 2, Groups A, B, C, and D, and Class II, Division 2, Groups F and G hazardous locations or non-hazardous locations only.

Warning - Explosion Hazard

Substitution of components may impair suitability for Class I, Class II, Division 2.

Advertissement Risque D'Explosion

La substitution de composants peut rendre ce matériel inacceptable pour les emplacements de classe I, II, Division 2.

Warning - Explosion Hazard

Do not disconnect equipment unless the power has been disconnected or the area is known to be non-hazardous.

Advertissement Risque D' Explosion

Avant de deconnecter l'équipement, couper le courant ou s'assurer que l'emplacement est désigné non dangereux.

Advertissement Risque D' Explosion

Dans les situations hasardees, couper la courant avant de remplacer ou de cabler les modules.

Warning - Explosion Hazard

When operating in hazardous locations, disconnect power before replacing or wiring modules.

Warning

To maintain a safe condition, do *not* use an external keyboard or mouse when the unit is operating in a hazardous environment.

Definitions

The following Class and Division explanations are derived from Article 500 (Sections 5 and 6) of the United States National Fire Protection Agency National Electric Code (NFPA 70, 1990). They are not complete and are included here as a general description for those not familiar with generic hazardous location requirements.

People responsible for installing this equipment in hazardous locations are responsible for ensuring that all relevant codes and regulations related to location rating, enclosure, and wiring are met.

Class I Locations

Class I locations are those in which flammable gases or vapors are or may be present in the air in quantities sufficient to produce explosive or ignitable mixtures.

Class II Locations

Class II locations are those that are, or may become, hazardous because of the presence of combustible dust.

Division 1 Locations

Division 1 locations are those in which flammable or ignitable gases, vapors, or combustible dusts and particles can exist due to the following conditions:

- Normal operating conditions.
- Because of repair, maintenance conditions, leakage, or where mechanical failure or abnormal operation of machinery or equipment might release or cause explosive or ignitable mixtures to be released or produced.
- Combustible dusts of an electrically conductive nature may be present in hazardous quantities.

Note

Xycom Automation systems are not suitable for installation within Division 1 locations.

Note

Electrical equipment cannot be installed in Division 1 locations unless it is intrinsically safe, installed inside approved explosion-proof enclosures, or installed inside approved purged and pressurized enclosures.

Division 2 Locations

Division 2 locations are listed below:

- Class I volatile flammable liquids or flammable gasses are handled, processed, or used, but confined within closed containers or closed systems from which they can escape only in cases of accidental rupture or breakdown of such enclosures or systems, or in case of abnormal operation of equipment.
- Ignitable concentrations of Class I vapors or gasses are normally prevented by positive mechanical ventilation, but which may become hazardous due to mechanical failure of those ventilation systems.
- Location is adjacent to a Division 1 location.
- Class II combustible dust is not normally in the air in quantities sufficient to produce explosive or ignitable mixtures. Dust accumulations are normally insufficient to interfere with normal operation of electrical equipment or other apparatus. Combustible dust may be in suspension in the air as a result of the following: infrequent malfunctioning of handling or processing equipment; combustible dust accumulations on, or in the vicinity of electrical equipment; may be ignitable by abnormal operation or failure of electrical equipment.

Group Ratings

All electrical equipment that is approved for use in hazardous locations must include a group rating. Various flammable and combustible substances are divided into these groups as a function of their individual maximum experimental safe gap (MESG), explosion pressure, and ignition temperature.

Component temperatures and the potential for spark based upon voltage, current, and circuit characteristics, within electrical equipment, will determine what the equipment group rating will be. A device approved for installation within Class I, Group A locations may also be used in Groups B, C, or D.

Note

Approved Class I equipment may not be suitable for Class II installations. Class I includes Groups A, B, C, and D. Class II includes Groups F and G.

Enclosures

The systems are designed to be installed within clean and dry enclosures for both ordinary and hazardous locations. The front panel meets the requirements of UL and CSA Type 4, 4X, and 12 enclosures. The enclosure used for Class I hazardous locations should have a minimum rating of Type 12 (NEMA 12, IP 5X). However, Type 4 (IP 6X) enclosures are strongly recommended.

Panel flatness and rigidity are important to maintain a proper panel seal. If you are going to use non-metal type enclosures, such as plastic or fiberglass, install a rigid metal stiffener behind the front panel. Failure to do so may result in an inadequate panel seal due to flexure of the front panel material between the stud mounts. Tighten the nuts on the mounting studs per the instructions in the previous section, "*Mounting the Unit.*"

Requirements for enclosure fittings, conduit, and wiring vary according to the specific rating of the location and the type of flammable or combustible material involved. Those requirements are beyond the scope of this document. It is the customer's responsibility to ensure that the installation is compliant with codes and regulations that apply to the specific location. Reference NFPA 70, Article 500 for specific regulations in the United States.

Power Switch

The systems do not have a power switch. The amount of input power required by these systems classifies the power switch as an incendiary device because the voltage and current across the make/break device are capable of creating a spark.

Hazardous location regulations state that a power switch rated for ordinary locations may be used if it is located in a non-hazardous area. However, limits in cable length between the workstation and the power switch may apply. Otherwise, the switch must be compliant with Class I, Division 1 requirements (intrinsically safe). These switches are built in a manner that prevents the possibility of a spark when contacts are made or broken.

Use suitable UL-listed and/or CSA-certified Class I, Division 1 switches in hazardous locations. These switches are available from a number of sources. It is the customer's responsibility to ensure that the power switch selected for the installation has the correct hazardous location rating for the location in which it is installed.

Cable Connections

Division 2 hazardous location regulations require that all cable connections be provided with adequate strain relief and positive interlock. Never connect or disconnect a cable while power is applied at either end of the cable.

All communication cables should include a chassis ground shield. This shield should include both copper braid and aluminum foil. The D-sub style connector housing should be a metal conductive type (e.g., molded zinc), and the ground shield braid should be well terminated directly to the connector housing. Do not use a shield drain wire.

The outer diameter of the cable must be suited to the inner diameter of the cable connector strain relief to ensure that a reliable degree of strain relief is maintained. Always secure the D-Sub connectors to the workstation mating connectors via the two screws located on both sides.

Warning

Never connect or disconnect the communication cables while power is applied at either end of the cable. This may result in an incendiary spark. Permanent damage to the workstation communication components may occur.

Operation and Maintenance

The systems have been designed to comply with relevant spark ignition tests. However, the workstation front panel membrane switches are the only make/break components intended to be used by the operator in normal operation.

Warning

To maintain a safe condition, do *not* use an external keyboard or mouse when the unit is operating in a hazardous environment.

Always observe the following rules with respect to hazardous location installations:

1. Always install the workstations within an enclosure suitable for the specific application. General-purpose enclosures may be acceptable for Class I applications, but are never acceptable for Class II applications. Type 4 (IP 65) enclosures are recommended even when not required by regulations.
2. Keep enclosure doors or openings closed at all times to avoid the accumulation of foreign matter inside the workstation.
3. Never subject the unit to any installation or service procedures unless power is removed and the area is non-hazardous. This includes installing or removing power cables or communication cables, or removing the unit's back cover.
4. Only technically qualified service personnel should perform installation and service. These workstations are designed to require no service in the course of normal operation by an operator.

Safety Agency Approval

The 3408, 3410 and 3412 systems have been designed to meet the following standards:

- *Underwriters Laboratories Inc., UL 1604 Standard for Safety*
Electrical equipment for use in Class I and Class II, Division 2, and Class III hazardous (classified) locations
- *Underwriters Laboratories Inc., UL 1950*
Information Technology Equipment
- *Canadian Standard Association, Specification C22.2 No. 213-M1987*
Non-incendiary electrical equipment for use in Class I, Division 2 hazardous locations
- *Canadian Standards Association, Specification C22.2 No. 950*
Information Technology Equipment
- *EN60950, Information Technology Equipment*

Chapter 4 -- Keypad Functionality (3408KP/3410KP/3412KP)

The 3408KP, 3410KP and 3412KP include function/alpha, control/alpha, numeric, and cursor control keypads.

Control Keypad

3408KP

This keypad provides seven control keys, six alpha keys (U-Z) and the space and + keys. The CTRL, SHIFT, INS, ALT, TAB, DEL, SPACE, and + keys provide the same functions as they do on a standard PC/AT-compatible keyboard.

Six of the keys are relegendable, as shown in Figure 4 -1. Refer to the *Creating Customized Keypad Inserts* section in Chapter 3 for detailed information.

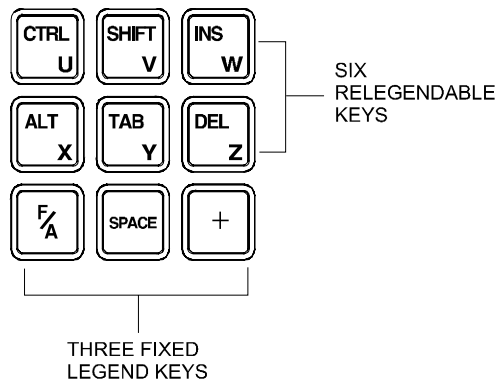

Figure 4-1. 3408KP Control/Alpha Keypad

3410KP/3412KP

This keypad provides seven control keys, and the space and + keys. The CTRL, SHIFT, INS, ALT, TAB, DEL, SPACE, and + keys provide the same functions as they do on a standard PC/AT-compatible keyboard. Six of the keys are relegendable, as shown in Figure 4 -2. Refer to the *Creating Customized Keypad Inserts* section in Chapter 3 for detailed information.

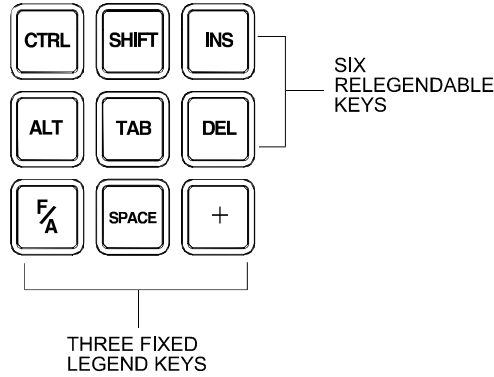

Figure 4-2. 3410KP Control Keypad

Alternate Configuration

The workstation comes with an alternate insert that you may use for these six re-legendable keys. This alternate insert replaces the PC control key labels with function key labels. Your unit is shipped with batch files (see Batch Utility Mode in Chapter 5) that you can use with the keypad utility to re-map the keys.

Function and Alpha Modes

The F/A key is unique to the 3408KP and 3410KP units. When you press and hold this key, the keypad switches to alpha mode. This allows you to access the alpha characters A-Z, as well as punctuation symbols on 3410KP units (as noted in the blue letters located in the bottom right-hand corner of the keys).

Note

On 3408KP units, the default setting for alpha characters is uppercase. If you want to use lowercase alpha characters, you must reprogram the keypads using the keypad utility (refer to Chapter 5 for more detailed information).

When the F/A key is not being pressed, the keypads are in function mode (as noted in the white letters located in the top left-hand corner of the keys).

Note

On 3408KP units, you cannot access the CTRL, SHIFT, INS, ALT, TAB, and DEL keys in alpha mode. This means that you cannot use these keys in combination with alpha keys (for example, you cannot use the CTRL+C key combination).

Contrast Control

You can use the cursor control keys in conjunction with the F/A key to control the contrast on 3408KP passive color flat-panel display units. To do this, hold down the F/A key while pressing a cursor control key.

Numeric Keypad

The numeric keypad features numbers 0-9, plus the decimal and minus sign characters.

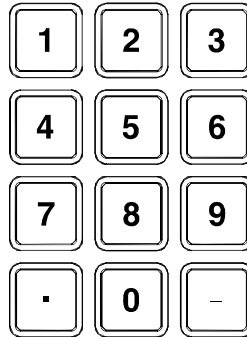

Figure 4-3. Numeric Keypad

Cursor Control Keypad

The cursor control keypad features 10 cursor control keys: BACKSPACE, PREV, NEXT, ESC, ENTER, HOME (the center key), and the up, down, right, and left arrow keys.

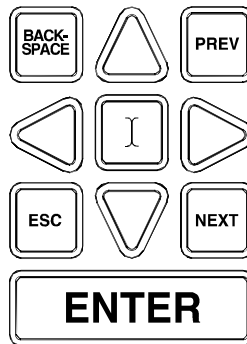

Figure 4-4. Cursor Control Keypad

You can use the cursor control keys in conjunction with the F/A key to control the contrast on 3408KP passive color flat-panel display units.

Function/Alpha Keypads

3408KP

The 20 function/alpha keys (F1-F20, A-T,) on the 3408KP are relegendable. Refer to the *Creating Customized Keypad Inserts* section in Chapter 3 for detailed information.

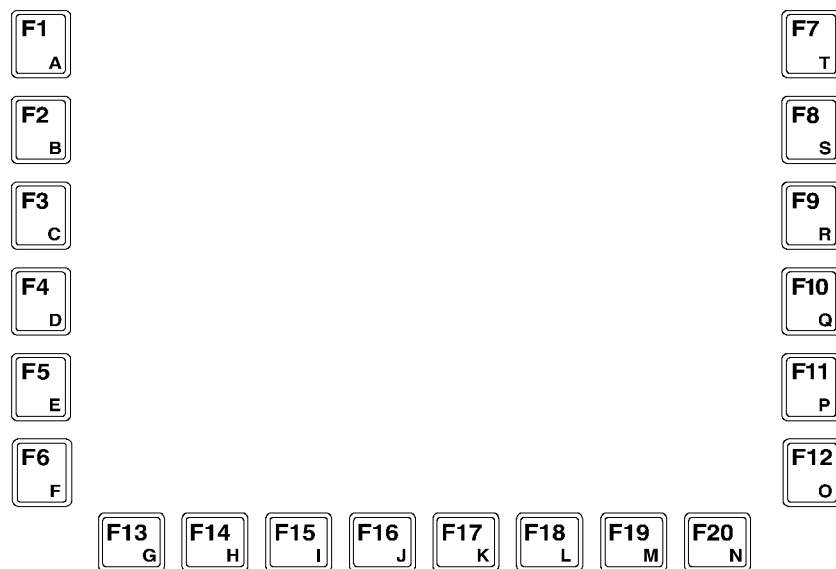

Figure 4-5. 3408KP Function/Alpha Keypads

3410KP

The 32 PF/function/alpha keys (PF1-PF12, F1-F20, and A-Z and punctuation symbols) on the 3410KP are relegendable. Refer to the *Creating Customized Keypad Inserts* section in Chapter 3 for detailed information.

The PF1-PF6 keys are equal to CTRL+F1 through CTRL+F6. PF7-PF12 are equal to ALT+F1 through ALT+F6.

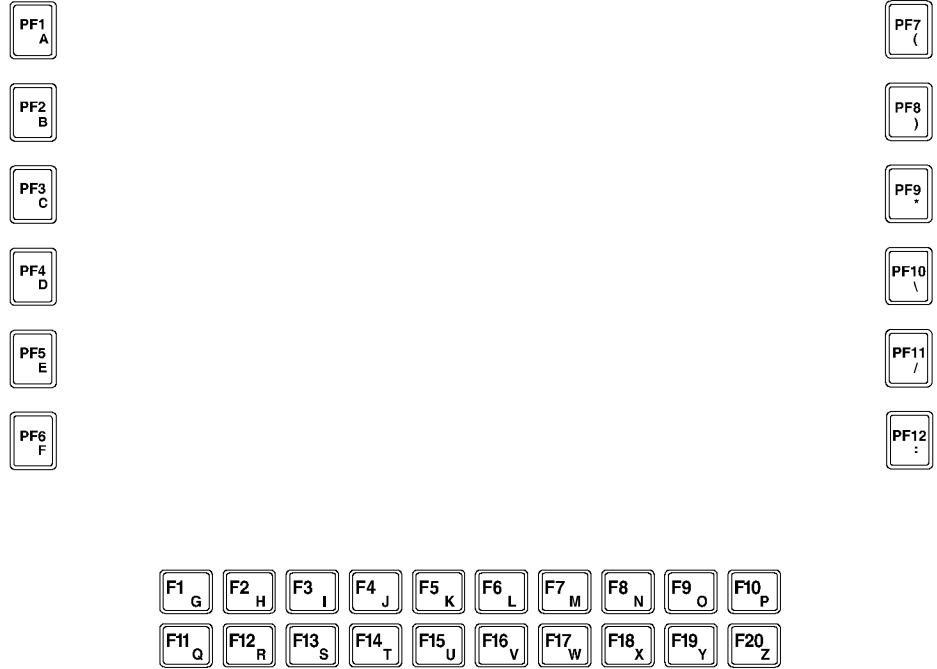

Figure 4-6. 3410KP PF/Function/Alpha Keypads

Chapter 5 -- Keypad Utility

3408KP/3410KP/3412KP

Note

The information in this chapter does not apply to units running the Windows CE operating system.

The Keypad Utility lets users redefine all keypad keys with new scan codes using utility software. Use an external full-stroke PC/AT keyboard to access the utility (you cannot redefine the keyboard).

Note

The keypad switch arrays are disabled while the keypad utility is running.

Loading the Keypad Utility

Note

You need MS-DOS 3.2 or higher to run the keypad utility. It will *not* work if you are running Windows 95 or Windows NT. However, the keypad utility will run under Windows 95 in DOS mode.

You can run this utility directly from the disk or copy it onto your hard drive. To run the keypad utility from the disk, change the directory to the appropriate drive and type `kputil`. To load the utility onto your hard drive, create a subdirectory for the files, and copy all the files on the disk into that subdirectory. Enter the subdirectory and type `kputil`.

Using the Keypad Utility

The keypad utility uses a menu bar and pull-down menu system. All menu bars are displayed across the top of the screen. "Xycom KP Utility" and the current menu titles are shown at the bottom of the screen (see Table 5-1). A full-stroke keyboard is needed to enter keystrokes while recording a new key macro, editing an existing macro, and enter-

ing utility commands. You can redefine all keys on the keypads. While the utility is running, the keypads are disabled.

Dialog boxes appear for user prompts and to display error and user advice messages.

Two keys allow you to exit the menus:

- ESC moves to the previous menu or out of the utility from the Main Menu.
- F1 returns to the current menu headings in some of the menu where Exit can be chosen to exit this menu.

Keys specific to each menu are shown at the bottom of each screen.

Startup

Type `kputil` to run the full keypad utility.

Utility Batch Mode

You can also use a batch file to reprogram keypads. This feature is useful if you wish to reprogram many units with customized keypad macros without having to enter the full keypad utility for each unit. Once the full utility has been used to create and save keypad macros, the files containing these macros can be included on a disk with the keypad utility and then used to reprogram other units from a batch file.

The command `keypad filename` runs the keypad utility batch mode. “*Filename*” is the file containing the new keypad macros. The filename extension must be included. For example, in a batch file, the command `keypad def3408PC.pkm` or `3408HMI.pkm` would reprogram the keypad on the 3408KP with default values for the numeric keypad. After programming, the system will reboot.

Main Menu

Table 5-1 illustrates the Main Menu.

Exit	Files	Macros	Upload	Download	Utilities
Xycom KP Utility: MAIN L-Arrow, R-Arrow, Enter					

Table 5-1. Main Menu

Exit

Exit closes open files and exits the utility. ESC can also be used for this purpose and for exiting the other menus.

Files Menu

You can save files containing keypad macro sets (a macro for each key) on disk, and then loaded them into memory to view, edit, teach, or download to the keyboard controller. Some of these files may be included in the utility package for use in reconfiguring the keypads for different software packages, and as templates for defining completely new keypad macro sets.

When you choose Files, a pull-down menu displays that provides the following choices: Open, Close, Save, Save As, Delete, and Exit. The following table describes the menu commands.

Command	Description
Open	Opens a file that contains a macro set for the keypad and loads the contents into memory. Any macro set in memory is overwritten. Once loaded, the macro set is available to edit, view, teach, or download to the keyboard controller.
Close	Clears the macro set from memory and closes the file from which they came.
Save	Copies the macro set from memory back into its original file. The original file contents are overwritten.
Save As	Creates a new file under the specified name and copies the macro set from memory into it. For example, to define different sets of codes, save each set under a different name and download the one you wish to use.
Delete	Deletes a file.
Exit	Returns to the Main Menu.

Macros Keypad Type Menu

When you select Macros, a pull down menu displays and provides the following choices: Function Keys, Alpha Keys, and Exit. Also, another pull down menu displays the following choices once the Macros menu is chosen: Exit, View, Teach, and Edit.

Note

You must have a macro file in memory before the Macros Menu is available. To load a macro file, Open a file or Upload macros.

Command	Description
Function Keys	Selects the function keys on the keypad to either view, edit, or teach.
Alpha Keys	Selects the alpha keys on the keypad to either view, edit, or teach.
Exit	Returns to the main menu.

Macros Edit Menu

Command	Description
Exit	Returns to the Main Menu.
View	<p>Lets you view, but not edit, the macro for the selected key. When View is chosen, the Exit option is displayed on the menu bar and a graphic representation of the chosen keypad is shown. Select Exit from the View Menu to return to the Macros Menu. To select a key to view, use the arrow keys to position the cursor on the desired key and press ENTER. The macro is displayed as two lines: ASCII and code. The ASCII line displays each keycode as the keys it represents on the full-stroke keyboard. Special labels are used for certain keys (e.g., Spc for space bar, UAr for up arrow, and bk for the break code prefix). The code line is displayed in either Hex or decimal. There is a one-to-one correspondence between the ASCII and code lines.</p> <p>While viewing the macro, the menu bar displays two options: Exit and Hex/Decimal. Exit returns to the View Menu, while Hex/Decimal toggles between displaying the macro in hex or decimal format. When Hex is chosen, the keycodes are displayed as hexadecimal value scan codes. When Decimal is chosen, the keycodes are displayed as the decimal equivalent of the hex codes.</p> <p>For example, the macro <i>abc</i> would be displayed as 1C F0 1C 32 F0 32 21 F0 21 in hex, and 28 240 28 50 240 50 33 240 33 in decimal.</p>
Teach	<p>Allows you to record up to 105 keystrokes in a macro. When selected, a graphic representation of the keypad currently in memory displays. Menu bar choices are Exit, ASCII/Hex/Decimal, and Click ON/OFF. Exit returns to the Macros menu. ASCII/Hex/Decimal specifies the format to display the keystrokes as they are entered. Default is ASCII. Click is not supported.</p> <p>To select a key to define, use the arrow keys to position the cursor on the desired key and press ENTER. After you select a key, the utility records every keystroke on the external full-stroke keyboard in a macro assigned to the chosen key. As the keys are entered, they are displayed using the chosen format. ESC stops recording and returns to the Teach Menu, so you cannot record the ESC key. However, ESC can be included in a macro by using the editor. Changes made to the macros in the Teach Menu are not programmed until you select Download.</p>

Command	Description
Edit	<p>Displays a graphic representation of the keypad in memory and a menu bar displaying Exit, Click, and ON/OFF. Exit returns to the Macros menu. Click is not supported. To select a key to edit, use the arrow keys to position the cursor on the desired key and press ENTER.</p> <p>In edit mode, the macro is displayed as two lines. The top line (the edit line) displays the macro in either hex or decimal format and is the line in which the editing takes place. The bottom line displays the macro in ASCII format; it is not user configurable. This line keeps track of which part of the macro you are editing, and is updated by the utility as editing takes place.</p> <p>The insert, delete, and cursor control keys are active for editing. When a key is selected from the Edit Macro option, the menu bar displays the following choices: Exit, Cut, Copy, Paste, Codes, Hex/Decimal, and I/O (Insert/Overtyp). The macro for the chosen key is also displayed.</p> <p>Cut deletes a sequence of scan codes from the macro. To select a section to cut:</p> <ol style="list-style-type: none"> 1. Place the cursor on the first character to cut. 2. Press F1 and select CUT. 3. Press ENTER. Cut should still be highlighted, but the cursor will appear on the Edit line. Move the cursor on the last character to cut and press ENTER. <p>The last character of every macro is the end of the macro (EOM) and cannot be deleted.</p> <p>Copy copies a sequence of scan codes from the macro into memory. To select the section to copy:</p> <ol style="list-style-type: none"> 1. Place the cursor on the first character to copy. Press F1 and select Copy. 2. Press ENTER. Copy should still be highlighted, but the cursor will appear on the Edit line. 3. Move the cursor on the last character to copy and press ENTER. <p>The copied item does not appear on the screen until you select Paste.</p> <p>Paste inserts a sequence of scan codes (which were saved in memory using Copy) into the macro. To paste a sequence of scan codes that were previously copied, position the cursor where you want the text to appear and then press F1. Select Paste and then press ENTER. Codes displays a table of keys and their scan codes in Hex. See the Codes section in this chapter for a complete code listing. Hex/Decimal toggles between displaying the scan codes in Hex and Decimal formats. Insert toggles between insert and overtype mode.</p>

Upload Menu

Use the Upload Menu to choose which data to load. Choices in this menu are: Combo Keypad, Keypad Version, and Exit.

Command	Description
Combo Keypad	Commands the keyboard controller to send its entire macro set for the keypad.
Keypad Version	Commands the keyboard controller to send its firmware revision number.
Exit	Returns to the Main Menu.

Note

Only one macro set may reside in memory at one time.

A checksum will be calculated during transmission. If an error occurs, an error message will display.

Download Menu

Note

When you select Download, any macro set previously programmed is overwritten.

Download sends the set of keypad macros to the keyboard controller. The macro set must reside in memory before it can be downloaded. A checksum is calculated during transmission and an error message displays if an error occurs.

As the macro is sent, keyboard controller programs its non-volatile memory with the new macros which become the new key definitions for the keypad. After programming, the system will reboot.

Utilities Menu

When Utilities is selected, a menu bar displays four choices: Func Lock ON, Func Lock OFF, Clear EEPROM, and Exit.

Command	Description
Func Lock ON	Not available on the 3408KP and 3410KP.
Func Lock OFF	Not available on the 3408KP and 3410KP.
Factory Default	Reprograms the keypad macros to the factory default settings. After completion, the system will reboot.
Exit	Returns to the Main Menu.

Keypad Scan Codes

Tables 5-2 through 5-8 list the default keypad scan codes produced by the keypad utility.

Table 5- 2. Keypad Codes for Lowercase Letters

Key	Edit Mode in Macros Edit Menu	Make Code	Break Code
a	1C	1C	F0 1C
b	32	32	F0 32
c	21	21	F0 21
d	23	23	F0 23
e	24	24	F0 24
f	2B	2B	F0 2B
g	34	34	F0 34
h	33	33	F0 33
i	43	43	F0 43
j	3B	3B	F0 3B
k	42	42	F0 42
l	4B	4B	F0 4B
m	3A	3A	F0 3A
n	31	31	F0 31
o	44	44	F0 44
p	4D	4D	F0 4D
q	15	15	F0 15
r	2D	2D	F0 2D
s	1B	1B	F0 1B
t	2C	2C	F0 2C
u	3C	3C	F0 3C
v	2A	2A	F0 2A
w	1D	1D	F0 1D
x	22	22	F0 22
y	35	35	F0 35
z	1A	1A	F0 1A

Table 5-3. Keypad Codes for Left-Shifted (Uppercase) Letters

Key	Edit Mode in Macros Edit Menu	Make Code	Break Code
A	12 1C	12 1C	F0 1C F0 12
B	12 32	12 32	F0 32 F0 12
C	12 21	12 21	F0 21 F0 12
D	12 23	12 23	F0 23 F0 12
E	12 24	12 24	F0 24 F0 12
F	12 2B	12 2B	F0 2B F0 12
G	12 34	12 34	F0 34 F0 12
H	12 33	12 33	F0 33 F0 12
I	12 43	12 43	F0 43 F0 12
J	12 3B	12 3B	F0 3B F0 12

K	12 42	12 42	F0 42 F0 12
L	12 4B	12 4B	F0 4B F0 12
M	12 3A	12 3A	F0 3A F0 12
N	12 31	12 31	F0 31 F0 12
O	12 44	12 44	F0 44 F0 12
P	12 4D	12 4D	F0 4D F0 12
Q	12 15	12 15	F0 15 F0 12
R	12 2D	12 2D	F0 2D F0 12
S	12 1B	12 1B	F0 1B F0 12
T	12 2C	12 2C	F0 2C F0 12
U	12 3C	12 3C	F0 3C F0 12
V	12 2A	12 2A	F0 2A F0 12
W	12 1D	12 1D	F0 1D F0 12
X	12 22	12 22	F0 22 F0 12
Y	12 35	12 35	F0 35 F0 12
Z	12 1A	12 1A	F0 1A F0 12

Table 5-4. Keypad Codes for Numeric and Punctuation Keys

Key	Edit Mode in Macros Edit Menu	Make Code	Break Code
`	0E	0E	F0 0E
1	16	16	F0 16
2	1E	1E	F0 1E
3	26	26	F0 26
4	25	25	F0 25
5	2E	2E	F0 2E
6	36	36	F0 36
7	3D	3D	F0 3D
8	3E	3E	F0 3E
9	46	46	F0 46
0	45	45	F0 45
-	4E	4E	F0 4E
=	55	55	F0 55
[54	54	F0 54
]	5B	5B	F0 5B
\	5D	5D	F0 5D
;	4C	4C	F0 4C
'	52	52	F0 52
,	41	41	F0 41
.	49	49	F0 49
/	4A	4A	F0 4A

Table 5-5. Keypad Codes for Left-Shifted Punctuation Keys

Key	Edit Mode in Macros Edit Menu	Make Code	Break Code
~	0E	0E	F0 0E
!	16	16	F0 16

@	1E	1E	F0 1E
#	26	26	F0 26
\$	25	25	F0 25
%	2E	2E	F0 2E
^	36	36	F0 36
&	3D	3D	F0 3D
*	3E	3E	F0 3E
(46	46	F0 46
)	45	45	F0 45
_	4E	4E	F0 4E
+	55	55	F0 55
{	54	54	F0 54
}	5B	5B	F0 5B
	5D	5D	F0 5D
:	4C	4C	F0 4C
"	52	52	F0 52
<	41	41	F0 41
>	49	49	F0 49
?	4A	4A	F0 4A

Table 5-6. Keypad Codes for Control & Miscellaneous Keys

Key	Edit Mode in Macros Edit Menu	Make Code	Break Code
Tab	0D	0D	F0 0D
Left Shift Tab	12 0D	12 0D	F0 0D F0 12
Caps Lock	58	58	F0 58
Left Shift	12	12	F0 12
Right Shift	59	59	F0 59
Left Ctrl	14	14	F0 14
Right Ctrl	E0 14	E0 14	E0 F0 14
Left Alt	11	11	F0 11
Right Alt	E0 11	E0 11	E0 F0 11
Space Bar	29	29	F0 29
Backspace	66	66	F0 66
Left Enter	5A	5A	F0 5A
Esc	76	76	F0 76
Insert	E2	E0 12 E0 70	E0 F0 70 E0 F0 12
Home	E3	E0 12 E0 6C	E0 F0 6C E0 F0 12
⌈	E3	E0 12 E0 6C	E0 F0 6C E0 F0 12
Page Up	E4	E0 12 E0 7D	E0 F0 7D E0 F0 12
PREV	E4	E0 12 E0 7D	E0 F0 7D E0 F0 12
Delete	E5	E0 12 E0 71	E0 F0 71 E0 F0 12
End	E6	E0 12 E0 69	E0 F0 69 E0 F0 12
Page Down	E7	E0 12 E0 7A	E0 F0 7A E0 F0 12
NEXT	E7	E0 12 E0 7A	E0 F0 7A E0 F0 12
Up Cursor	E8	E0 12 E0 75	E0 F0 75 E0 F0 12

Left Cursor	E9	E0 12 E0 6B	E0 F0 6B E0 F0 12
Right Cursor	EA	E0 12 E0 74	E0 F0 74 E0 F0 12
Down Cursor	EB	E0 12 E0 72	E0 F0 72 E0 F0 12
/	EC	E0 12 E0 4A	E0 F0 4A E0 F0 12
Print Screen	ED	E0 12 E0 7C	E0 F0 7C E0 F0 12
Pause/Break	EE	E0 12 E0 7E	E0 F0 7E E0 F0 12
SysRq PS2	ED	E0 12 E0 7C	E0 F0 7C E0 F0 12
SysRq 88 #1	84	84	F0 84
SysRq 88 #2	7F	7F	F0 7F
Scroll Lock	7E	7E	F0 7E
Num Lock	77	77	F0 77
Right *	7C	7C	F0 7C
Right -	7B	7B	F0 7B
Right +	79	79	F0 79
Right Enter	E0 5A	E0 5A	E0 F0 5A

Table 5-7. Keypad Codes for Numeric/Control Keys (with Numlock on)

Key	Edit Mode in Macros Edit Menu	Make Code	Break Code
.	71	71	F0 71
0	70	70	F0 70
1	69	69	F0 69
2	72	72	F0 72
3	7A	7A	F0 7A
4	6B	6B	F0 6B
5	73	73	F0 73
6	74	74	F0 74
7	6C	6C	F0 6C
8	75	75	F0 75
9	7D	7D	F0 7D
Del	12 71	12 71	F0 71 F0 12
Ins	12 70	12 70	F0 70 F0 12
End	12 69	12 69	F0 69 F0 12
Down Cursor	12 72	12 72	F0 72 F0 12
PgDn	12 7A	12 7A	F0 7A F0 12
Left Cursor	12 6B	12 6B	F0 6B F0 12
Blank	12 73	12 73	F0 73 F0 12
Right Cursor	12 74	12 74	F0 74 F0 12
Home	12 6C	12 6C	F0 6C F0 12
Up Cursor	12 75	12 75	F0 75 F0 12
PgUp	12 7D	12 7D	F0 7D F0 12

Table 5-8. Keypad Codes for Function Keys F1-F20

Key	Edit Mode in Macros Edit Menu	Make Code	Break Code
F1	FF 01	05	F0 05
F2	FF 02	06	F0 06
F3	FF 03	04	F0 04

F4	FF 04	0C	F0 0C
F5	FF 05	03	F0 03
F6	FF 06	0B	F0 0B
F7	FF 07	83	F0 83
F8	FF 08	0A	F0 0A
F9	FF 09	01	F0 01
F10	FF 0A	09	F0 09
F11	78	78	F0 78
F11 XYCOM	FF 0B	12 05	F0 05 F0 12
F12	07	07	F0 07
F12 XYCOM	FF 0C	12 06	F0 06 F0 12
F13	FF 0D	12 04	F0 04 F0 12
F14	FF 0E	12 0C	F0 0C F0 12
F15	FF 0F	12 03	F0 03 F0 12
F16	FF 10	12 0B	F0 0B F0 12
F17	FF 11	12 83	F0 83 F0 12
F18	FF 12	12 0A	F0 0A F0 12
F19	FF 13	12 01	F0 01 F0 12
F20	FF 14	12 09	F0 09 F0 12

Note

If you make any changes to your keypad and want to set it back to the default settings, open the file titled DEF3408PC .PKM or DEF3408HMI .PKM from the File/Open menu and then download it from the download menu. **Do not save any changes to the default files.**

Table 5- 9 Keypad Codes for Function Keys F21-F40 or PF1-PF20

Symbol	Edit Seq.	AT Make	AT Break	XT Make	XT Break
F21 or PF1	FF 15	14 05	F0 05 F0 14	1D 3B	BB 9D
F22 or PF2	FF 16	14 06	F0 06 F0 14	1D 3C	BC 9D
F23 or PF3	FF 17	14 04	F0 04 F0 14	1D 3D	BD 9D
F24 or PF4	FF 18	14 0C	F0 0C F0 14	1D 3E	BE 9D
F25 or PF5	FF 19	14 03	F0 03 F0 14	1D 3F	BF 9D
F26 or PF6	FF 1A	14 0B	F0 0B F0 14	1D 40	C0 9D
F27 or PF7	FF 1B	14 83	F0 83 F0 14	1D 41	C1 9D
F28 or PF8	FF 1C	14 0A	F0 0A F0 14	1D 42	C2 9D
F29 or PF9	FF 1D	14 01	F0 01 F0 14	1D 43	C3 9D
F30 or PF10	FF 1E	14 09	F0 09 F0 14	1D 44	C4 9D
F31 or PF11	FF 1F	11 05	F0 05 F0 11	38 3B	BB B8
F32 or PF12	FF 20	11 06	F0 06 F0 11	38 3C	BC B8
F33 or PF13	FF 21	11 04	F0 04 F0 11	38 3D	BD B8
F34 or PF14	FF 22	11 0C	F0 0C F0 11	38 3E	BE B8
F35 or PF15	FF 23	11 03	F0 03 F0 11	38 3F	BF B8
F36 or PF16	FF 24	11 0B	F0 0B F0 11	38 40	C0 B8
F37 or PF17	FF 25	11 83	F0 83 F0 11	38 41	C1 B8
F38 or PF18	FF 26	11 0A	F0 0A F0 11	38 42	C2 B8
F39 or PF19	FF 27	11 01	F0 01 F0 11	38 43	C3 B8
F40 or PF20	FF 28	11 09	F0 09 F0 11	38 44	C4 B8

Chapter 6 - Maintenance

The 3408, 3410 and 3412 units are designed to withstand the harsh environment of the factory floor. However, preventive and routine maintenance will help keep the system in good operating condition.

Preventive Maintenance

Preventive maintenance consists of several basic procedures that will reduce the chance of system malfunction. Schedule preventive maintenance along with the regular equipment maintenance to minimize down time.

Following are some preventive measures you can take:

- Clean the screen using a non-residue cleaner such as a mild window cleaning solution or CRT screen cleaner. Take care not to scratch or mar the screen face.
- Base your maintenance schedule on the type of environment the system is in (i.e., if the area is dusty, schedule maintenance more often than if it is a dry, clean area).
- Remove dust and dirt from PC components. If dust builds up on heat sinks and circuitry, an obstruction of heat dissipation could cause the unit to malfunction. If dust reaches the electronic boards, a short circuit could occur.
- Check connections to I/O modules, especially in environments where shock could loosen the connections. Check all plugs, sockets, and module connections.
- Remove unnecessary articles, such as drawings or manuals, from the unit. They can obstruct air flow and create hot spots, which causes the system to malfunction.
- Do not place noise-generating equipment near the unit.
- Replace the module with the correct type. If the new module solves the problem but the failure reoccurs, check for inductive loads that may be generating voltage and current spikes and may require external suppression.

Xycom Recommended Hard Drive Preventative Maintenance

Xycom Automation has recognized that hard drive failures may begin to increase an average of four to five years into the life of most computers used in industrial applications. Therefore, it is our recommendation as a preventative maintenance measure that all hard drives used in these types of applications be replaced before the four to five year time period to avoid any down time related to hard drive failure.

The purpose of this message is to merely bring this to our customer's attention, to offer alternative solutions, and to provide all of our customers with the excellent service they deserve.

Any questions regarding this issue may be directed to our support center at support@xycom.com.

Please note Xycom recommends frequent back ups of your hard drive, especially before beginning any preventative maintenance procedures.

Replacing the Fuse

The 3408, 3410 and 3412 units have no accessible fuse. Return the unit to Xycom Automation for fuse replacement.

Chemical Compatibility

Certain combinations of chemical environments, temperature, and stress can adversely affect parts made from thermoplastic resin. For this reason, material which may come in contact with 3408/3410/3412 units should be carefully evaluated under end-use conditions for compatibility. You should also follow the use and compatibility recommendations of the material manufacturer.

Table 6-1 lists general chemical compatibility guidelines.

Table 6 -1. Chemical Compatibility

Chemical Class	Effects
Acids	No effect under most common conditions of concentration and temperature.
Alcohols	Generally compatible at low concentration and room temperature. Higher concentrations and elevated temperatures result in etching and attack evidenced by decomposition.
Alkalis	Generally compatible at low concentration and room temperature. Higher concentrations and elevated temperatures result in etching and attack evidenced by decomposition.
Aliphatic Hydrocarbons	Generally compatible
Amines	Surface crystallization and chemical attack. Avoid.
Aromatic Hydrocarbons	Partial solvents and severe stress cracking agents. Avoid.
Detergents and cleaners	Mild soap solutions are compatible. Strong alkaline materials should be avoided.
Esters	Causes severe crystallization. Partial solvents. Avoid.
Greases and oils	Pure petroleum types generally compatible. Many additives used with them are not compatible.
Halogenated Hydrocarbons	Solvents. Avoid.
Ketones	Causes severe crystallization and stress cracking. Partial solvents. Avoid.
Silicone oil and greases	Generally compatible up to 85° C (185° F). Some contain aromatic hydrocarbons which should be avoided.

Compatible Lubricants

Table 6 -2 lists known compatible lubricants and the manufacturers' names. If you want to use a lubricant that is not listed in the table, contact the appropriate manufacturer to determine compatibility.

Table 6 -2. Compatible Lubricants

Lubricants	Manufacturer
DC® 230 Molykote® 33	Dow Corning Midland, MI 48640 (800) 248-2345
Harmony® 68 Security® 68	Gulf Oil Petroleum Prod. Dept. Pittsburgh, PA 15230 (412) 655-6247
Lubriplate® Aero	Fisher Bros. Refinery 129 Lockwood Street Newark, NJ 07105
Martemp® 2500	E.F. Houghton & Co. 303 W. Lehigh Ave. Philadelphia, PA 19133 (215) 666-4000
Nyogel® 795A Rheolube® 368 Rheolube® 723G Rheolube® 788 Synthetic Oil® 181	Wm. J Nye P.O. Box G-927 New Bedford, MA 02742 (617) 966-6721
SF® 1147 Versilube® F-50	GE Silicone Products Waterford, NY 12188 (518) 237-3330
Terrestic ® 77	Exxon P.O. Box 2180 Houston, TX 77092 (713) 680-5712

Compatible Cleaning Agents

Table 6-3 lists known compatible cleaning agents. If you want to use a cleaning agent that is not listed in the table, contact the appropriate manufacturer to determine compatibility.

Table 6 -3. Compatible Cleaning Agents

Type	Agents
Aliphatics	Hexane, Heptane, White Kerosene Mineral Spirits, Petroleum Ethers (65° C boiling point)
Alcohols	Methyl, Isopropyl and Isobutyl, 1 + 3 Denatured Alcohol
Halogenated hydrocarbons	Freons TF & TE
Detergents and cleaners	Mild Soap and Water Solution, VM&P Naphtha Fantastik®, Windex®, Joy®, Top Job®, Mr. Clean®, Formula 409®

Compatible aliphatics, alcohols, and halogenated hydrocarbons should be used only for wiping or short-term immersion (less than 10 minutes). If parts are in complete immersion, remove all traces of solvent by forced-air drying or rinsing in hot water.

Non-compatible Cleaning Agents

Table 6-4 lists cleaning agents known to be detrimental.

Table 6 -4. Non-Compatible Cleaning Agents

Type	Agents
Bases	25% Ammonium Hydroxide, 10% Potassium Hydroxide, Sodium Hydroxide
Organic Solvents	Lacquer Thinner, Toluene, Methyl Cellosolve, Methyl ethylketone

Spare Parts

Stock spare parts to minimize down time resulting from part failure. The spare parts stocked should be 10 percent of the number of each unit used. Main CPU cards should have one spare each. Each power supply should have a back-up. In applications where immediate operation of a failed system is required, you may need to stock an entire spare computer module.

Table 6-5 provides a list of spare parts along with their Xycom Automation part numbers.

Table 6 -5. 3408/3410/3412 Spare Parts List

Description	Xycom Automation Part Number
Front Panel Assembly	
3408T	129969-001
3408KP	129971-001
3410T	130589-001
3410KP	130548-001
3410KPT	130563-001
3412T	139680-001
3412KP	139681-001
3412KPT	139682-001
Hard Drive	
2.5-inch IDE	129984-001
8 MB Flash	139626-001
16 MB Flash	139640-001
24 MB Flash	139677-001
48 MB Flash	139678-001
CHIP4e+ 133 MHz CPU board	130034-001
DRAM	
4M x 32 (16 Mbytes)	104302
8M x 32 (32 Mbytes)	106054
16M x 32 (64 Mbytes)	123514
Replacement Bulb Assembly	
3408 STN	130021-001
3410 TFT	121663-001
3412 TFT	125155-001
AC Input Power Connector	99711-001
External Floppy Kit (9000-EXF)	116074-001

Product Repair Program/Returning a Unit to Xycom Automation

Xycom Automation's Product Repair and Customization Department (PR&C) restores equipment to normal operating condition, and implements engineering changes that enhance operating specifications. Returned products are tested with standard Xycom Automation test diagnostics.

Follow the steps below to prepare the unit for shipment:

1. Obtain an RMA number for your unit by calling your nearest Xycom Automation Repair Department or Xycom Automation at 1-800-289-9266 or 734-429-4971.

Please have the following information available:

- Company name and shipping and billing addresses

- Type of service desired: product repair or product exchange
 - Product model number, part number, quantity, serial number(s), and warranty status
 - Failure mode and failure systems
 - Purchase order number or repair order number
2. Make sure the front panel assembly is properly attached to the unit.
 3. Attach failure information to the unit to speed processing.
 4. Place the unit securely in its original packaging or an equivalent heavy-duty box.
 5. Mark the RMA number on your purchase order and on the outside of the box.
 6. Send the unit to the address given when you receive your RMA number.

Appendix A– Technical Specifications

Hardware Specifications

Table A-1. Hardware Specifications

Characteristic	Specification
Mechanical	
3408T	
Height	9.0" (front panel)
Width	10.6" (front panel)
Length	4.20" overall; 3.3" behind front panel
Weight	9 lbs
3408 KP	
Height	9.0" (front panel)
Width	12.0" (front panel)
Length	4.20" overall; 3.3" behind front panel
Weight	9 lbs
3410T	
Height	11.0" (front panel)
Width	13.0" (front panel)
Length	4.5" overall; 3.5" behind front panel
Weight	11 lbs
3410KP	
Height	12.25" (front panel)
Width	16.6" (front panel)
Length	4.5" overall; 3.5" behind front panel
Weight	12 lbs
3412T	
Height	11.00"
Width	13.00"
Length	4.5" overall; 3.5" behind front panel
Weight	11 lbs
3412KP(T)	
Height	12.25"
Width	16.5"
Length	4.5" overall; 3.5" behind front panel
Weight	12 lbs
Electrical	
AC Power	90 to 250 VAC, 50-60 Hz, autosensing 1A maximum at 90 VAC
DC Power	18 to 36 V, 24 volts nominal 2.5 A maximum at 18 V
Power Supply	40 watts output

Characteristic	Specification
Available Power	With CHIP4e+ CPU board + 5 V @ .8 A +12 V @ .25 A -12 V @ .25 A Total not to exceed 6 watts
Mounting	Panel Mount
Flat-Panel Display 3408s 3410s	25,000-hour half-life bulbs 7.7" STN passive color LCD 10.4-inch TFT active matrix color LCD
Agency Approvals	UL 1950 UL 1604 CUL C22.2, No. 950 CUL C22.2, No. 213-M1987
Regulatory Compliance	FCC 47 CFR. Part 15, Class A CE EMI EN55022, Class A IMMUNITY EN50082-2:1995 SAFETY EN60950

Environmental Specifications

Table 0-2. Environmental Specifications

Characteristic	Specification
Temperature Operating Non-operating	0° to 50° C (32° to 122° F) -20° to 60°C (-4° to 140°F)
Humidity Operating Non-operating	20% to 80% RH non-condensing 20% to 80% RH non-condensing
Altitude Operating Non-operating	Sea level to 10,000 feet (3048 m) Sea level to 40,000 feet (12192 m)
Vibration (<i>no rotating media</i>) Frequency Operating Non-operating	5 to 2000 Hz 0.006" peak-to-peak displacement 1.0g maximum acceleration 0.015" peak-to-peak displacement 2.5 g maximum acceleration
Shock (<i>no rotating media</i>) Operating Non-operating	15g peak acceleration, 11 msec duration 30g peak acceleration, 11 msec duration

Appendix B – Pinouts

This appendix provides pinouts for the external connectors on the CHIP4e+ board.

Parallel Port Connector

This 25-pin DB connector supports ECP and EPP.

Pin	Signal
1	STROBE
2	PD(0)
3	PD(1)
4	PD(2)
5	PD(3)
6	PD(4)
7	PD(5)
8	PD(6)
9	PD(7)
10	PACK
11	PBUSY
12	PE
13	SELECT
14	AUTOFEED
15	PERROR
16	INIT
17	SELIN
18	GND
19	GND
20	GND
21	GND
22	GND
23	GND
24	GND
25	GND

PS/2 Keyboard Connector

This connector provides an external keyboard interface. This port uses a polyswitch to protect VCC from directly shorting to GND.

Pin	Signal
1	KB_DATA
2	NC
3	GND
4	5VFUSE
5	KB_CLK
6	NC

Warning

To maintain a safe condition, do *not* use an external keyboard or mouse port when the unit is operating in a hazardous environment.

Mouse Port Connector

This connector provides an external mouse interface. This port uses a polyswitch to protect VCC from directly shorting to GND.

Pin	Signal
1	AUX_DATA
2	NC
3	GND
4	5VFUSE
5	AUX_CLK
6	NC

Warning

To maintain a safe condition, do *not* use an external keyboard or mouse port when the unit is operating in a hazardous environment.

External Floppy Drive Connector

This 26-pin connector allows you to connect an external floppy. This port uses a poly-switch to protect VCC from directly shorting to GND.



Pin	Signal	Pin	Signal
1	+5V	14	FSTEP*
2	IDX*	15	NC
3	FDS1*	16	FWD*
4	+5V	17	GND
5	NC	18	FWE*
6	DCHG*	19	GND
7	NC	20	FTK0*
8	NC	21	GND
9	GND	22	FWP*
10	MO1*	23	GND
11	NC	24	FRDD*
12	FDIRC*	25	GND
13	NC	26	FHS*

Power Connector

This three-pin connector provides AC or DC input power to the unit.

Pin	AC Signal	DC Signal
1	L	+DC
2	N	-DC
3	AC_GND	GND

Ethernet Connector

This eight-pin connector provides 10BASE-T and 100BASE-TX Ethernet connections.

Pin	Signal
1	TX+
2	TX-
3	RX+
4	Short to pin 5 75ohm to TERMPANE
5	Short to pin 4 75ohm to TERMPANE
6	RX-
7	Short to pin 8 75ohm to TERMPANE
8	Short to pin 7 75ohm to TERMPANE

COM1 Connector

This nine-pin connector actually consists of two connectors (RS-232 and RS-485) attached to one logical port. Only one connector can be used at a time.

RS-232 Connector

The lower nine-pin connector provides the RS-232 protocol.

Pin	Signal
1	DCD1
2	RXD1
3	TXD1
4	DTR1
5	GND
6	DSR1
7	RTS1
8	CTS1
9	RI1

RS-485 Connection

The upper nine-pin connector provides the RS-485 protocol.

Pin	Signal
1	TXD-
2	TXD+
3	TXD TERM -
4	TXD TERM +
5	GND
6	RXD-
7	RXD+
8	RXD TERM +
9	RXD TERM -

Note

For TXD termination, connect a 150Ω, ½-watt resistor from pin 3 to pin 4, with pin 1 connected to pin 3 and pin 2 connected to pin 4.

For RXD termination, connect a 150Ω, ½-watt resistor from pin 8 to pin 9 with pin 6 connected to pin 9 and pin 7 connected to pin 8.

COM2 Connector

You can configure this port for use with one of three separate devices: the touch screen controller, infrared (IR, IrDA) interface, or RS-232 connector. The BIOS setup determines whether COM2 is used for the RS-232 connector or the IR interface. Jumpers on the touch screen controller select the COM2 or mouse ports. When the touch screen controller is jumpered for COM2, COM2 is unavailable for other use.

Pin	Signal
1	ORB_GND
2	TXD2
3	RXD2
4	RTS2
5	CTS2
6	DSR2
7	GND
8	DCD2
9	NC
10	NC
11	PB_RESET*
12	NC
13	NC
14	NC
15	NC
16	NC
17	NC
18	NC
19	NC
20	DTR2
21	NC
22	RI2
23	NC
24	NC
25	NC

This connector also contains the remote system reset option. A normally open pushbutton switch can be connected to pins 11 and 7. When the switch is pressed, the PB_RESET* signal is forced to GND, which causes the CPU to reset. To enable this option, you must set jumper J1 to position B.

Appendix C – Replacing Flat-Panel Display Bulbs

This appendix describes how to replace the bulbs in your flat-panel display.

Note

Refer to the label on the back of your unit to determine which model you have. If you are unsure which bulb to use, call Xycom Automation Customer Support at 800-289-9266.

3408 Units

Kyocera STN Flat-Panel Display (Model #KCS077VG2EA-A03)

1. Disconnect the power cable, as well as any other external cables.
2. Unscrew the three back cover mounting screws (refer to the figures in Chapter 3 if you need help locating these screws).
3. Slide the back cover toward the I/O panel, and lift off.
4. Disconnect the cable connected to the touchscreen connector (TCH1) at the top of the unit and the keypad connector.
5. Loosen the four screws holding the flat-panel display carrier to the front panel. These screws remain attached to the carrier.
6. Carefully lift off the carrier.
7. Flip the unit over to expose the flat-panel display.
8. Disconnect the two bulb connectors (pink and white wires) on the right-hand side of the display.
9. Remove the four screws attaching the display to the front-panel standoffs.
10. Lift the right side of the flat-panel display up, and disconnect the data interface connectors on the bottom side of the display.
11. Place the flat-panel display face down on a protective surface.
12. While pushing in the white tab at the left end of the bulb assembly, lift up the same end and slide the entire bulb assembly to the left to remove.

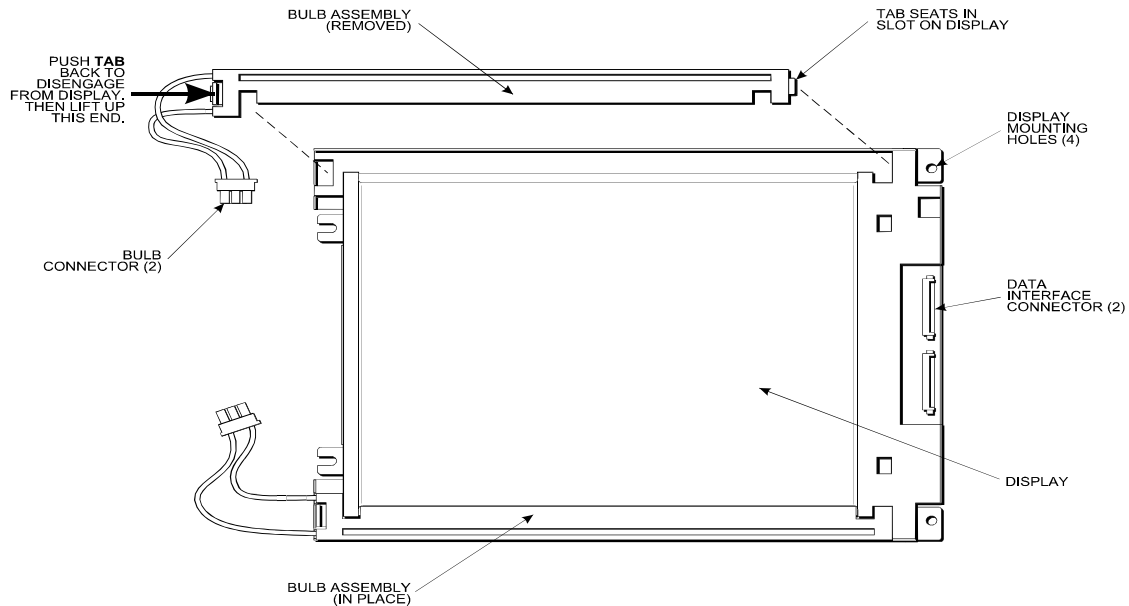

Figure C- 1. Model #KCS077VG2EA-A03 Bulb Assembly Removal

Note

Do *not* lift the bulb assembly straight up, as there is a tab that is inserted in a slot on the right side of the display.

13. Take the new bulb assembly, and slide the tab on the right side into the slot on the right side of the display.
14. When the tab is properly inserted, push down on the bulb assembly until the tab on the left side of the assembly clicks into place.

Note

We recommend that you replace both bulbs at the same time.

15. Repeat steps 12 through 14 to replace the other bulb assembly.
16. Reverse steps 1 through 11 to reassemble the unit.

3410 Units

Sharp TFT Flat-Panel Display (Model #LQ10D421)

1. Disconnect the power cable, as well as any other external cables.
2. If the unit does not incorporate a touchscreen, go to Step 5. If the unit incorporates a touchscreen, unscrew the three back cover mounting screws (refer to the figures in Chapter 3 if you need help locating these screws).
3. Slide the back cover toward the I/O panel, and lift off.
4. Disconnect the cable connected to the touchscreen connector (TCH1) at the top of the unit and/or the keypad connector.
5. Set the unit with the front panel down, and loosen the four captive screws holding the flat-panel display carrier to the front panel. These screws remain attached to the carrier.
6. Carefully lift off the carrier.
7. Flip the unit over to expose the flat-panel display.
8. Disconnect the two bulb connectors attached to the inverter board.
9. Remove the four screws attaching the flat-panel display to the front-panel standoffs.
10. Locate the bulb assembly on the top edge of the flat-panel display.
11. Insert a flat-bladed screwdriver in the opening at the end of the bulb assembly, as shown in Figure C- 2, and push up until the bulb assembly releases.

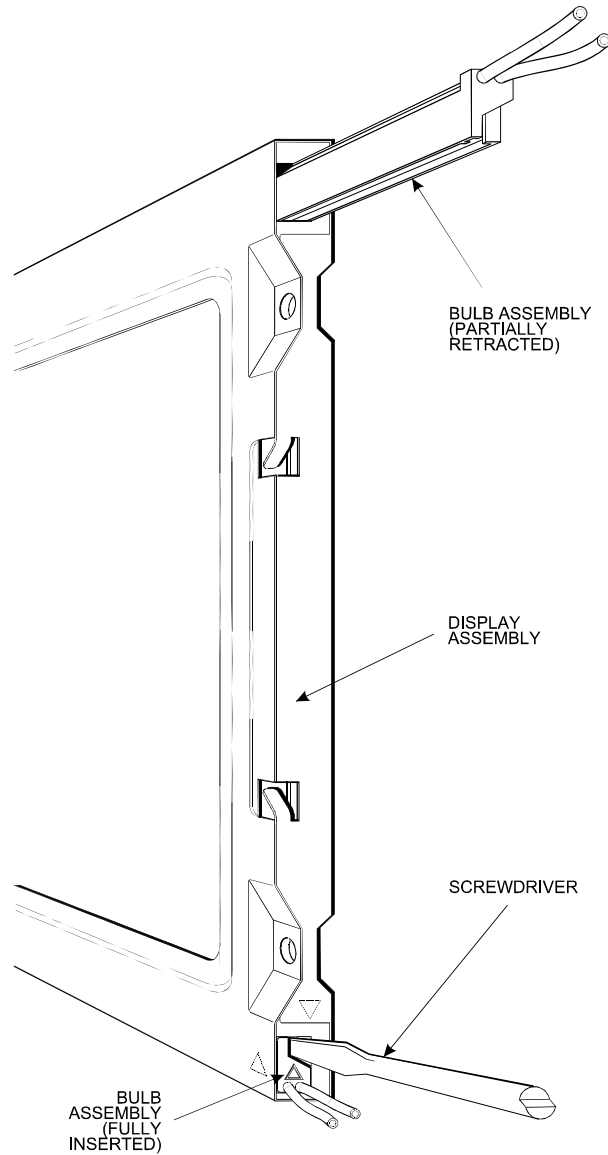

Figure C- 2. Model #LQ10D421 Bulb Assembly Removal

12. Slide out the bulb assembly.
13. Carefully slide the new bulb assembly into the opening from which the old assembly was removed.

Note

We recommend that you replace both bulb assemblies at the same time.

14. Repeat steps 11 through 13 to replace the bulb assembly on the bottom edge of the flat-panel display.
15. Reverse steps 1 through 9 to reassemble the unit.

3412 Units

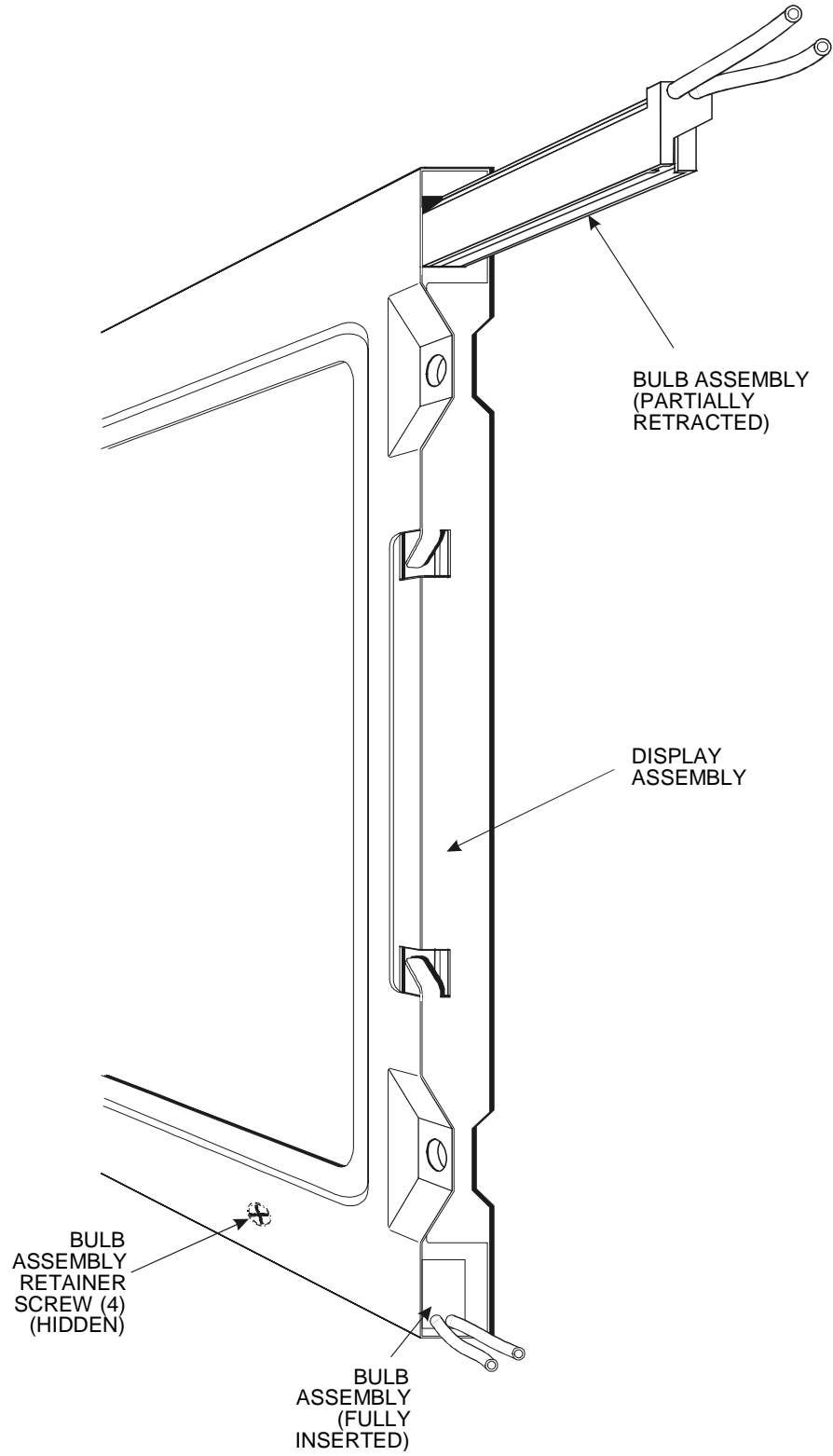

Model #LQ12541 Bulb Assembly Removal

Sharp TFT Flat-Panel Display (Model #LQ12541)

1. Disconnect the power cable, as well as any other external cables.
2. If the unit does not incorporate a touchscreen, go to Step 5. If the unit incorporates a touchscreen, unscrew the three back cover mounting screws (refer to the figures in Chapter 3 if you need help locating these screws).
3. Slide the back cover toward the I/O panel, and lift off.
4. Disconnect the cable connected to the touchscreen connector (TCH1) at the top of the unit and/or the keypad connector.
5. Set the unit with the front panel down, and loosen the four captive screws holding the flat-panel display carrier to the front panel. These screws remain attached to the carrier.
6. Carefully lift off the carrier.
7. Flip the unit over to expose the flat-panel display.
8. Disconnect the two bulb connectors attached to the inverter board.
9. Locate the bulb assembly on the top edge of the flat-panel display.
10. Unscrew retainer screws from attaching tabs at each end of the bulb assembly.
11. Slide out the bulb assembly.
12. Carefully slide the new bulb assembly into the opening from which the old assembly was removed and align with retainer screws.

Note

We recommend that you replace both bulb assemblies at the same time.

13. Repeat steps 11 and 12 replacing the bulb assembly on the bottom edge of the flat-panel display.
14. Reconnect bulb connectors.
15. Torque down retainer screws.
16. Complete reassembly.

Appendix D – Installing the IDE Flash Drive

As an additional storage option, you can install an IDE flash drive on your 3408/3410 unit.

Installing the IDE Flash Drive

Warning

You must disconnect the power cable, as well as any other external cables connected to the unit, before removing the back cover.

Perform the following steps to replace the IDE Flash drive:

1. Disconnect the power cable, as well as any other external cables.
2. Unscrew the three back cover mounting screws (refer to the back panel figures in Chapter 3 if you need help locating these screws).
3. Slide the back cover toward the I/O panel, and lift off.
4. Disconnect the cable connected to the touchscreen connector (TCH1) at the top of the unit or the keypad connector and the display cable under the power supply.
5. Loosen the four screws holding the flat-panel display carrier to the front panel. These screws remain attached to the carrier.
6. Carefully lift off the carrier.
7. Flip the unit over to expose the flat-panel display.
8. Disconnect the two bulb connectors (pink and white wires) on the right-hand side of the display.
9. Remove the four screws attaching the display to the front-panel standoffs.
10. Place the flat-panel display face down on a protective surface.
11. Remove the four screws and lift off the hard drive.
12. Remove the Flash drive card by pushing down on the piece of metal and pulling out the card. Replace with the new Flash drive card, as shown in Figure D-1.

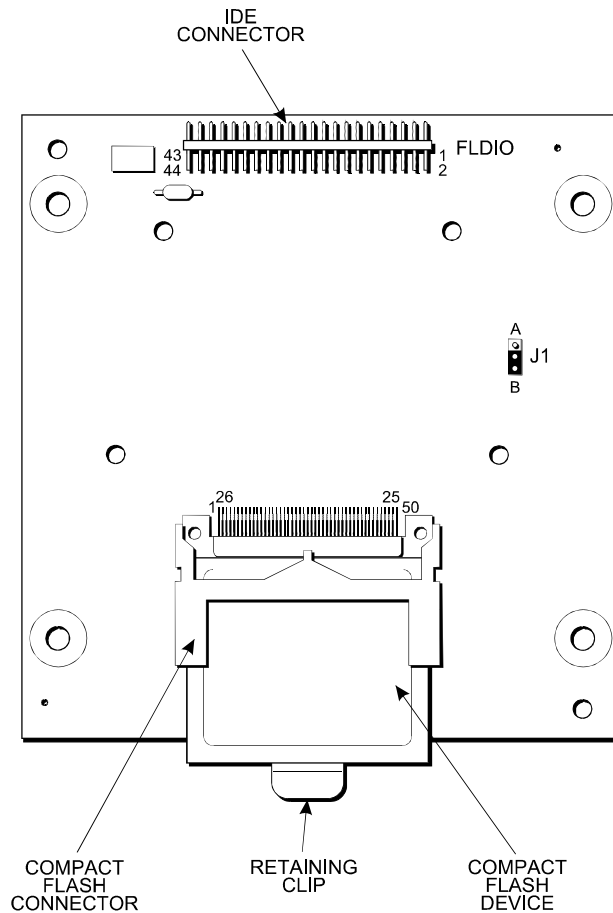

Figure D-1. IDE Flash Drive

13. Reverse the steps to reassemble the unit.

Configuring the IDE Flash Drive

Perform the following steps to configure the IDE Flash drive:

1. Press F2 to access the BIOS setup menus.
2. In the Main Menu, select the IDE Adapter 0 Master item, and press and press ENTER.
3. Highlight the Autotype Fixed Disk entry and press ENTER.
4. Next, press ESC to access the Exit menu.
5. Highlight the Save Changes & Exit entry, and press ENTER.

The Flash drive has been automatically configured.

Index

- 3400KP
 - back panel, 21
 - cutout dimensions, 47
 - front panel, 15
 - I/O panel, 20
 - IR port, 15
 - power panel, 22
- 3400N
 - back panel, 21
- 3400T
 - back panel, 21
 - cutout dimensions, 46
 - front panel, 13
 - I/O panel, 20
 - IR port, 14
 - power panel, 22
- 3408 Units, 87
- 3408/3410 Power Panels, 22
- 3408/3410/3412 I/O Panel, 20
- 3408KP, 57, 60
- 3408KP Cutout Dimensions, 47
- 3408KP Front Panel, 14
- 3408KP Keypad Inserts, 28
- 3408T Cutout Dimensions, 46
- 3408T/3410T Front Panel, 13
- 3410 Units, 89
- 3410KP, 60
 - back panel, 21
 - cutout dimensions, 49
 - I/O panel, 20
 - IR port, 16
 - power panel, 23
- 3410KP and 3410KPT Front Panel, 16
- 3410KP/3412KP, 57
- 3410KP/3412KP Cutout Dimensions, 49
- 3410KP/3412KP Keypad Inserts, 31
- 3410T
 - back panel, 21
 - cutout dimensions, 48
 - front panel, 13
 - I/O panel, 20
 - IR port, 14
 - power panel, 23
- 3410T/3412T Cutout Dimensions, 48
- 3412 Units, 91
- 3412KP Front Panel, 19
- 3412KPT Front Panel, 18
- 3465
 - display, 18
- AC Power Cable, 39
- AC power supply, 50
- AC Power Supply, 50
- agency approvals, 81
- alpha keys, 15, 16
- alpha mode, 15, 16
- Alternate Configuration, 58
- altitude, 81
- back cover, 22
- back panel, 21
- Back Panel, 21
- boards, PC/104, 26
- bulbs, flat-panel display, 87
- cable connections, 54
- Cable Connections, 54
- calibrating the touch screen, 39
- Calibrating the Touchscreen, 38
- chemical compatibility, 75
 - cleaning agents, 77
 - lubricants, 76
 - non-compatible cleaning agents, 77
- Class I Locations, 52
- Class II Locations, 52
- cleaning agents
 - compatible, 77
 - non-compatible, 77
- COM1
 - connector, 85
 - port, 20
- COM1 Connector, 85
- COM2
 - connector, 86
 - port, 20
- COM2 Connector, 86
- Compatible Lubricants, 76
- Configuring the IDE Flash Drive, 94
- connectors
 - COM1, 85
 - COM2, 86
 - Ethernet, 84
 - external floppy drive, 84
 - floppy drive, 23
 - parallel port, 82
 - power, 23, 84
 - PS/2 keyboard port, 83
 - PS/2 mouse port, 83
 - serial loopback, 11
 - UART1. *See* COM1
 - UART2. *See* COM2
- contrast control
 - 3400KP, 15, 59

- 3400T, 14
- 3410KP, 16
- 3410T, 14
- control keys, 15, 16
- control/alpha keypad, 57
- creating a power cable, 39
- Creating a Power Cable, 39
- Creating Customized Keypad Inserts, 28
- cursor control keypad, 59
- Cursor Control Keypad, 59
- cursor control keys, 15, 17
- custom
 - keypad inserts, 28
 - logo:, 27
- cutout dimensions
 - 3400KP, 47
 - 3400T, 46
 - 3410KP, 49
 - 3410T, 48
- DC Power Cable, 40
- DC power supply, 50
- DC Power Supply, 50
- Definitions, 52
- diagnostic tests
 - preparation, 10
 - running, 12
- display
 - 3460KP/3462KP, 19
 - 3465, 18
- Division 1 Locations, 52
- Division 2 Locations, 53
- DRAM
 - part numbers, 24
- DRAM, 23
- DRAM Single In-line Memory Modules (SIMMs), 23
- drivers
 - Ethernet, 34
 - touch screen, 35, 36
 - video, 34
- drives, floppy disk, 22
- Electrical Noise, 43
- electrical specifications, 80
- Enclosures, 54
- enclosures, hazardous locations, 54
- environmental specifications, 81
 - altitude, 81
 - humidity, 81
 - shock, 81
 - temperature, 81
 - vibration, 81
- Ethernet connector, 84
- Ethernet Connector, 84
- Ethernet drivers, 34
- Excessive Heat, 43
- expansion power, 50
- Expansion Power, 50
- expansion, PC/104, 26
- external floppy drive
 - connector, 84
 - installation, 27
- External Floppy Drive, 27
- External Floppy Drive Connector, 84
- F/A key, 15, 16
- fasteners, 22
- features
 - optional, 7
 - standard, 6
- flat-panel display bulbs, replacing, 87
- floppy disk drive
 - connector, 23
 - external, 22
- front panel
 - 3400KP, 15
 - 3400T, 13
 - 3410T, 13
- Front Panel, 13
- Function and Alpha Modes, 58
- function keys, 15, 16, 19
- function mode, 15, 16
- function/alpha keypads, 60
- fuse, replacing, 75
- Group Ratings, 53
- group ratings, hazardous locations, 53
- hardware specifications, 80
- hazardous location definitions
 - Class I locations, 52
 - Class II locations, 52
 - Division 1 locations, 52
 - Division 2 locations, 53
- hazardous location installations, 50
- Hazardous Location Installations, 50
- hazardous locations
 - cable connections, 54
 - enclosures, 54
 - group ratings, 53
 - maintenance, 55
 - operation, 55
 - power switch, 54
- heat, excessive, 43
- humidity, 81
- I/O panel, 20
 - 3400KP, 20
 - 3400T, 20
 - 3410KP, 20
 - 3410T, 20
- Infrared. *See* IR
- infrared port. *See* IR port
- installation

- DRAM, 23
- external floppy drive, 27
- external hardware, 27
- hazardous locations, 50
- keypad inserts, 33
- operating systems, 33
- panel, 42
- touch screen drivers, 35, 36
- Installation, 13
- Installing Ethernet Drivers, 34
- Installing External Hardware Options, 27
- Installing Internal Hardware Options, 23
- Installing the IDE Flash Drive, 93
- Installing the System into a Panel, 42
- Installing Touchscreen Drivers, 35
- Installing Video Drivers, 34
- IR port, 18
 - 3400KP, 15
 - 3400T, 14
 - 3410KP, 16
 - 3410T, 14
- keyboard port, 19, 20
- keyboard port (front access)
 - 3410KP, 17
- Keypad Functionality, 57
- keypad inserts
 - customized, 28
 - installation, 33
- Keypad Utility, 62
- Keypad Utility Program, 62
- keypads
 - alpha mode, 58
 - control/alpha, 57
 - cursor control, 59
 - function mode, 58
 - function/alpha, 60
 - numeric, 59
 - PKIM utility scan codes, 68
- keys
 - alpha, 15, 16
 - contrast control, 14
 - control, 15, 16
 - cursor control, 15, 17
 - F/A, 15, 16
 - function, 15, 16, 19
 - numeric, 15, 17
 - relegendable, 15, 16
 - user-defined, 19
- LEDs, 14, 18, 19
- line voltage variation, 43
- Line Voltage Variation, 43
- loading the PKIM utility, 62
- logo, customized, 27
- lubricants, compatible, 76

- maintenance, 74
 - cleaning the unit, 77
 - hazardous locations, 55
- Maintenance, 74
- mounting
 - studs, 22
- mounting considerations, 44
- Mounting Considerations, 44
- mounting the unit, 44, 81
- Mounting the Unit, 44
- mouse port, 20
- Mouse Port Connector, 83
- Noise, electrical, 43
- numeric keypad, 59
- Numeric Keypad, 59
- numeric keys, 15, 17
- operating systems, installation, 33
- operation and maintenance, 55
- Operation and Maintenance, 55
- operation, hazardous locations, 55
- panel installation, 42
- panel mounting studs, 22
- parallel port, 20
- parallel port connector, 82
- Parallel Port Connector, 82
- PC/104 boards, 26
- PC/104 Boards, 26
- pinouts
 - COM1 connector, 85
 - COM2 connector, 86
 - Ethernet connector, 84
 - external floppy drive connector, 84
 - parallel port, 82
 - power connector, 84
 - PS/2 keyboard port, 83
 - PS/2 mouse port, 83
- Pinouts, 82
- PKIM utility
 - Download menu, 67
 - Exit menu, 64
 - Files menu, 64
 - keypad scan codes, 68
 - loading, 62
 - Macros Edit menu, 65
 - Macros Keypad Type Menu, 64
 - Main menu, 63
 - Upload menu, 66
 - using, 62
 - Utilities menu, 67
- ports
 - COM1, 20
 - COM2, 20
 - IR, 18
 - 3400KP, 15

- 3400T, 14
 - 3410KP, 16
 - 3410T, 14
 - keyboard, 20
 - mouse, 20
 - parallel, 20
 - power
 - available, 81
 - cable, creating, 39
 - connector, 23, 84
 - expansion, 50
 - receptacle, 23
 - supply
 - AC, 50
 - DC, 50
 - specifications, 80
 - switch, 54
 - system, 42
 - Power Connector, 84
 - power panel
 - 3400KP, 22
 - 3400T, 22
 - 3410KP, 23
 - 3410T, 23
 - Power Panel, 22
 - Power Supply, 50
 - Power Switch, 54
 - Preventive Maintenance, 74
 - printer port. *See* parallel port
 - product repair, 78
 - PS/2 Keyboard Connector, 83
 - PS/2 keyboard port connector, 83
 - PS/2 mouse port connector, 83
 - Quick Start-up, 8
 - relegendable keys, 15, 16
 - replacing
 - flat-panel display bulbs, 87
 - fuse, 75
 - Replacing Flat-Panel Display Bulbs, 87
 - Replacing the Fuse, 75
 - returning a unit, 78
 - RS-232 Connector, 85
 - RS-485 Connection, 85
 - safety agency approval, 56
 - Safety Agency Approval, 56
 - serial loopback connections, 11
 - shock, 81
 - SIMMs. *See* DRAM
 - spare parts, 77
 - specifications
 - electrical, 80
 - environmental, 81
 - flat-panel display, 81
 - hardware, 80
 - mechanical, 80
 - power supply, 80
 - Specifying a Touchscreen Port, 36
 - Startup, 63
 - System Overview, 6
 - system power, 42
 - System Power, 42
 - system status LEDs, 18
 - Technical Specifications, 80
 - temperature, 81
 - Testing, 10
 - touch screen, 8
 - calibrating, 39
 - drivers, installation, 35, 36
 - using, 35
 - touchscreen, 36, 37
 - UART1. *See* COM1. *See* COM1
 - UART2. *See* COM2. *See* COM2
 - unit, returning, 78
 - Unpacking the System, 8
 - user-defined keys, 19
 - Using a Touchscreen, 35
 - using the PKIM Utility, 62
 - Utility Batch Mode, 63
 - vibration, 81
 - video drivers, 34
- Error! Cannot open file referenced on page 3**

340002(C)

Xycom Automation, Inc.
734-429-4971 • Fax: 734-429-1010
<http://www.xycomautomation.com>

XYCOMTM
AUTOMATION
a subsidiary of Pro-face America